

The NITTA Advantage-Innovative Products and Solutions



Wide Variety

Long Life

Abrasion Resistance

High Flexibility

Anti-Static

PolyBelt™

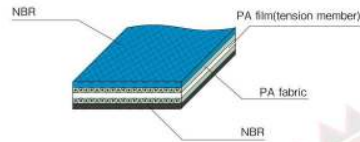

Standard Elongation ... 1%

Type Code

[PA Film Thickness (mm)×1000]
 500 ... 0.5 mmT×1000
 350 ... 0.35 mmT×1000

SG - **500**
L - **350**

[Surface material]
 SG ... Slight green coated fabric
 L ... Light
 M ... Middle
 H ... Heavy

Super-strong polyamide core, extended-life skived joining, high operating duty cycles

High Strength, Long Life

High flexibility and rugged design for heavy-duty applications. Polyamide core accommodates shock loads, and wide choice of covers provide abrasion resistance, giving long, dependable service.

Electrically Conductive

Materials with anti-static properties are used in specific layers to provide permanent conductivity, eliminating build-up of electro-static charges.

Environmental Resistance

Selected materials are not susceptible to oil contamination. They demonstrate high energy efficiency and maintain high friction resistance. Covers and polyamide core are designed for printing and paper processing with high tear resistance in folder, sheeting and finishing line paper jams.

PolySprint™

PE fabric tension member type

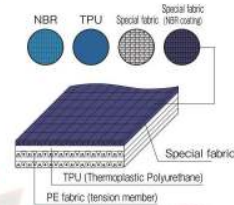

Standard Elongation ... 1%

Type Code

[Belt Thickness (mm)×10]
LA - **4E 14**
FZ - **5E 12**

[Belt Tension (N/mm)]
 (1% Elongation at 200hrs running)

[Surface material]
 LA ... Blue NBR on both surfaces
 FZ ... Special Fabric+NBR on bottom side

Finger-spliceable, easy installation, quick-melt urethane, high-strength polyester core

Ease of Joining

A single action Nitta cutter eliminates the tedious task of multiple cuts that can lead to mismatched and non-aligned joints. Finger-splice joints are completed without adhesive. Nitta presetter guiderails assure alignment.

Dimensional Stability

Polyester fabric used as tension member provides high dimensional stability. Selected materials are temperature and humidity tolerant.

Abrasion Resistance

High temperature friction resistant covers and fabric exclusively designed for printing and paper.

Elastic Type

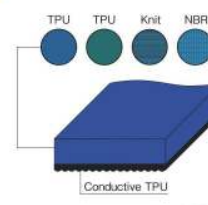

Standard Elongation ... 5%

Type Code

[Belt Thickness (mm)×10]
TA **09**
GTD

[Surface material]
 TA ... Blue TPU
 GTD ... Dark blue NBR+TPU

NLG™

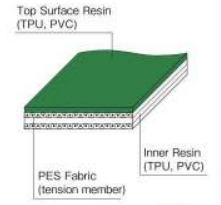

Standard Elongation ... 0.5%

(Depending on type)

Type Code

[Belt Construction]
 A ... Resin/Fabric
 D ... Fabric/Fabric

GUTW - **12 A**
GU - **12 A**

[Strength (N/mm)+10]

[Surface material]
 GUTW ... Green TPU+TW pattern
 GU ... Green TPU

Hundreds of configurations, wide variety of surfaces

Extensive Selection

Nitta NLG (New Light Grip) and other product categories offer many possible options.

Many Applications

Light-/medium-duty use throughout pressrooms and binderies.

Belts for Printing

【 Features 】

- ▶ Abrasion Resistance
- ▶ High Accuracy in Conveyance
- ▶ Long Life

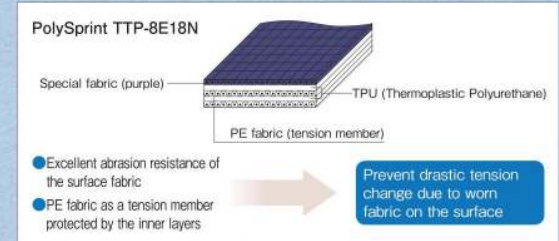
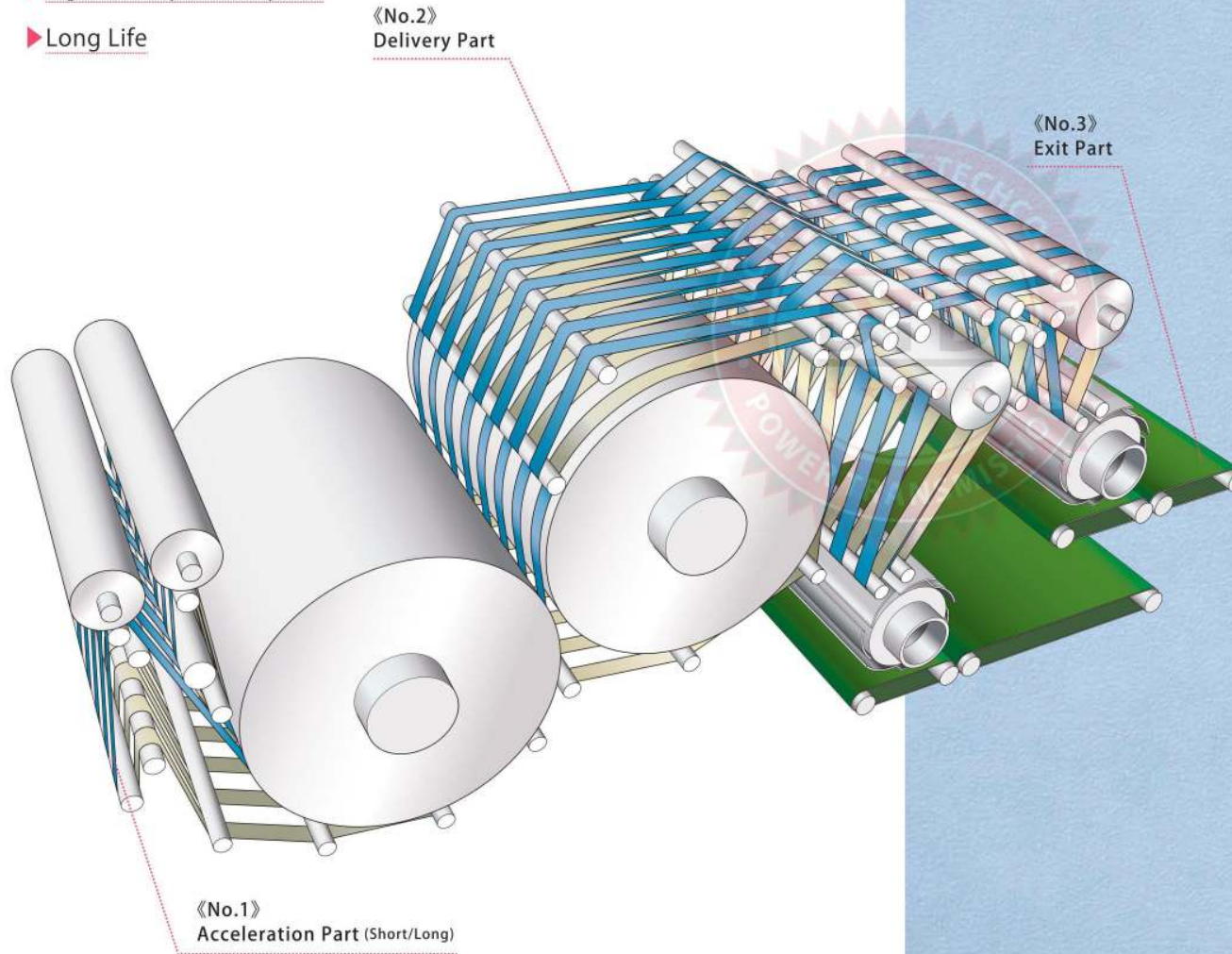

Gravure Rotary Press

No.	Part	Recommended belt type		Features
		Products	Type	
1	Acceleration Part (Short/Long)	PolySprint	TTP-8E18N	Durability of splicing point, abrasion resistance
2	Delivery Part (after folding part)	PolySprint	TTP-8E18N	Durability of splicing point, abrasion resistance
3	Exit Part	NLG	GUSRB-14ANL GUTW-12A etc.	Strong grip due to coefficient of friction, general use

Offset Sheet Fed Press

Part	Recommended belt type		Features
	Products	Type	
Sheet Feeder	PolySprint	FZ-5E12 TTZ-4E10LF TTF-4E10 etc.	Abrasion resistance, stable coefficient of friction
	PolyBelt	TPS-3SN SG types	

Offset Web Press

Part	Recommended belt type		Features
	Products	Type	
Folder	PolySprint	TTZ-4E10LF etc.	Moderate slip, abrasion resistance, flange resistance
	PolyBelt	TPS-3SN SG types L types	
Chopper	PolySprint	FZ-5E12 TTZ-4E10LF	Moderate slip, abrasion resistance, flange resistance, high tension
	PolyBelt	SG types	
Exit, stacker	NLG	GUSRB-14ANL GUTW-12A etc.	Strong grip

Belts for Bookbinding

【 Features 】

- ▶ Friction Coefficient
Suitable for Converting Paper Suitable for Converting Paper--Stable conveyance, abrasion resistance.
- ▶ Soft Fabric on the Surface
Avoids Damage to paper Intermittent running, Stopper part. Minimizes wet ink transfer.
- ▶ Finger Splicing Easy splicing process. Change belts out quickly, no adhesive and no experience required. Outstandingly smooth surface of splice does not catch paper.
- ▶ Dimensional Stability
(Polyester Fabric Member) Tension less affected by temperature changes, High accuracy in conveying and reducing trial running.

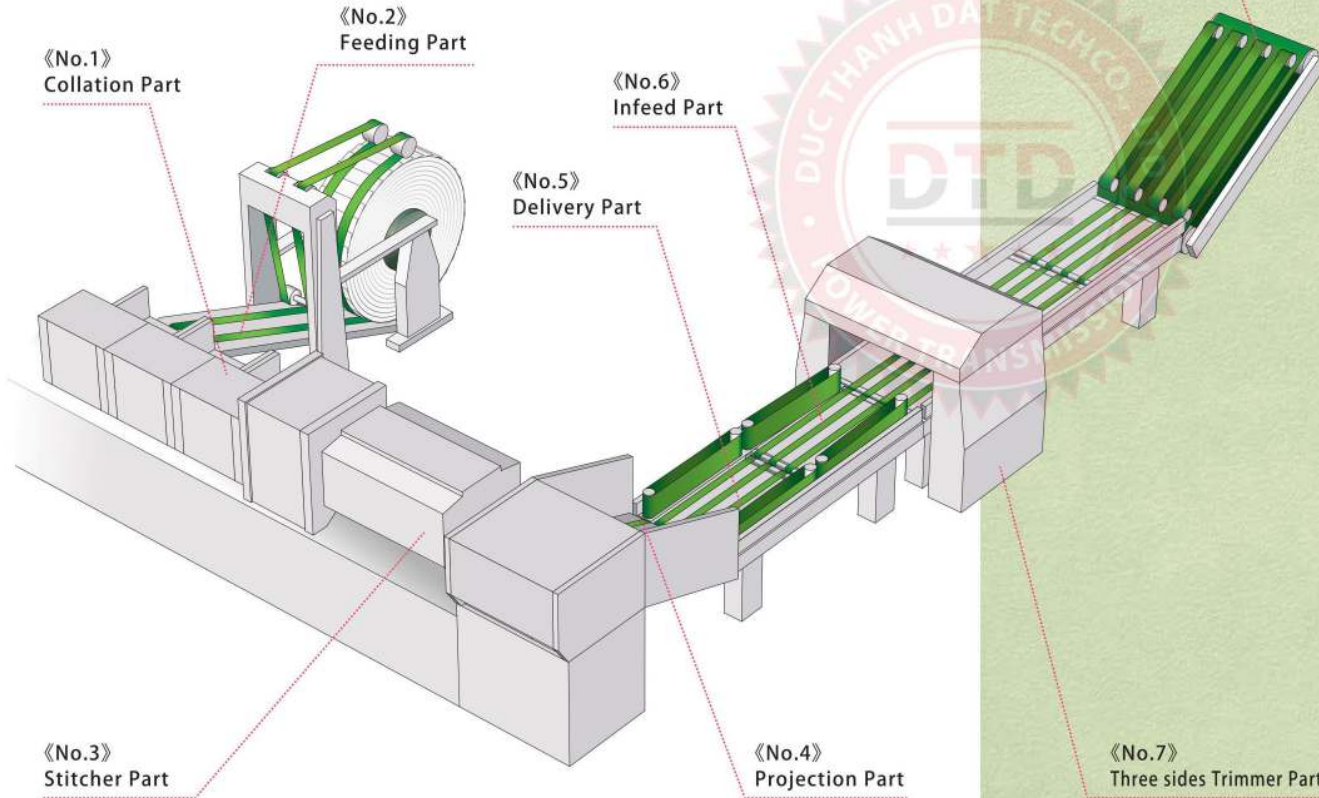

Inside-Binding Bookbinder

No.	Part	Recommended belt type		Features
		Products	Type	
1	Collation Part	PolySprint	LA-4E14 FZ-5E12	High flexibility
2	Feeding Part	PolySprint	FZ-5E12	Strong grip due to coefficient of friction
		NLG	GUSRB-14ANL etc.	
3	Stitcher Part	—	—	—
4	Projection Part	PolySprint	FZ-5E12 TTZ-4E10LF	Strong grip, abrasion resistance
5	Delivery Part	PolySprint	FZ-5E12 TTZ-4E10LF	Stable coefficient of friction, flange resistance
6	Infeed Part	PolySprint	FZ-5E12 TTZ-4E10LF	Stable coefficient of friction, twist resistance
7	Three sides Trimmer Part	PolySprint	FZ-5E12 TTF-4E10 TTZ-4E10LF	Soft Surface, high flexibility
8	Stacker Part	PolySprint	FZ-5E12 TTZ-4E10LF	Stable coefficient of friction, flange resistance

Collator

Part	Recommended belt type		Features
	Products	Type	
Vertical Conveyance	PolySprint	LA-4E14 SLA-8E14	Stable coefficient of friction
Exit	PolySprint	TA09 TA12 HTA09 GTD NTD etc.	Elastic type, stable tension

Folding machine

Part	Recommended belt type		Features
	Products	Type	
Feeding	PolySprint	LA-4E14 SLA-8E14 FZ-5E12 TTZ-4E10LF	Stable coefficient of friction
	PolyBelt	L types	
Folding	PolySprint	FZ-5E12 TTZ-4E10LF etc.	Moderate slip, abrasion resistance, flange resistance
	PolyBelt	SG types	

Splicing Tools (PolySprint™, PolyBelt™)

PolySprint™ PolyBelt™

PolySprint™

Quick and Easy Splicing (No Experience Required)

Finger Splicing (No Adhesive Needed)

Nitta's PolySprint tools make it quick and easy to replace broken belts with minimal downtime. Our presses are designed with small profiles to fit into tight spaces, so there is no need to disassemble the machine.



▼ Finger Puncher

Item No.	Type	Appearance	Features	Max. Belt Width (mm)	Max. Belt Thickness (mm)	Size			Wt. (kg)	Finger Length × Pitch (mm)
						W (mm)	L (mm)	H (mm)		
1	FP30-10-50N		Single action punching system	50	2.0	135	400	390	3.4	30×10
	FP30-10-100		Single action punching system	100	2.0	200	500	504	7.0	30×10
2	FP70-10-50		Precise indexing system, Allows user to punch aligned 10mm pitch fingers in stages across the width of the belt	50	6.0	180	600	250	9.0	70×10
3	FP120-10-50			120×10						
4	FP70-10-100		Precise indexing system, Allows user to punch aligned 10mm pitch fingers in stages across the width of the belt	100	6.0	230	610	250	10.4	70×10
5	FP120-10-100			120×10						

▼ Heating Press

Item No.	Type	Appearance	Features	Max. Belt Width (mm)	Max. Belt Thickness (mm)	Size			Wt. (kg)	Finger Length × Pitch (mm)	Power	Temp. (°C)
						W (mm)	L (mm)	H (mm)				
6	NPS-3050 H1		Heat press for Finger Splicing, Heat press with digital temperature readout	50	2.0	84	250	100	1.5	30×10	100V	~200
	NPS-3050 H2	200V										
	NPS-0310 H1		Heat press for Finger Splicing, Heat press with digital temperature readout	100	2.0	107	365	112	4.1	30×10	100V	~200
	NPS-0310 H2	200V										
7	NPS-1210-1		Automated heating and cooling press	100	6.0	230	320	180	9.5	70×10 120×10	100V	~200
	NPS-1210-2	200V										

▼ Cooling Press

Item No.	Type	Appearance	Features	Max. Belt Width (mm)	Max. Belt Thickness (mm)	Size			Wt. (kg)	Finger Length × Pitch (mm)
						W (mm)	L (mm)	H (mm)		
8	NPS-3050C		Cooling press for Finger Splicing no power required.	50	2.0	80	224	92	0.6	30×10
	NPS-0310C									

▼ Accessories

Item No.	Type	Appearance	Features
9	Presetter		Guide rails to hold joint straight when pressing
10	Clamp (2 Pieces)		Clamps for holding presetter together when pressing (Press 6 & 8)
11	PolySprint Toolkit Complete 30mm Finger Joining Kit		FP30-10-50N, NPS3050H, NPS3050C, Presetter, Clamps and Case Total weight 7.8kg W43×H37×T16

PolyBelt™

▼ Poly Skiver

Item No.	Type	Appearance	Features	Max. Belt Width (mm)	Max. Belt Thickness (mm)	Size			Wt. (kg)	Power
						W (mm)	L (mm)	H (mm)		
12	PS153		PolyBelt skiver for making a skived splicing. Highly reliable and widely accepted	150	3.0	400	380	435	33	100V or 200V

▼ Poly Press

Item No.	Type	Appearance	Features	Max. Belt Width (mm)	Max. Belt Thickness (mm)	Size			Wt. (kg)	Power	Temp. (°C)
						W (mm)	L (mm)	H (mm)			
13	PP051 (PI-50)		PolyBelt press for skiver splicing Lightweight, easy to use and widely accepted	50	2.5	112	160	90	1.3	100V or 200V	110
	PP103										

*PolyBelt splicing tools require the correct type of chemical adhesive (polybond) for the belt being made endless.



NITTA CORPORATION

4-4-26 Sakuragawa Naniwa-ku, Osaka 556-0022 Japan
Phone:+81-6-6563-1225 Fax:+81-6-6563-1242
<http://www.nitta.co.jp>

NITTA CORPORATION OF AMERICA

7605 Nitta Drive, Suwanee, GA 30024, U.S.A.
Phone:+1-770-497-0212 Fax:+1-770-623-1398
<http://www.nitta.com>

NITTA CORPORATION OF HOLLAND B.V.

Berenkoog 25, 1822 B.H. Alkmaar, The Netherlands
Phone:+31-72-5622234 Fax:+31-72-5613238
<http://www.nitta.nl>

NITTA (SHANGHAI) MANAGEMENT CO., LTD

Room2705, Shenggao International Building, No.137 Xianxia Road, Shanghai 200051
Phone:+86-21-6229-6000 Fax:+86-21-6229-9606
<http://www.nitta-cn.com>

NITTA CORPORATION INDIA PVT. LTD.

Gat No.191, 192, 193-Plot B, Village Vadhu Khurd, Haveli Taluka, Pune-412 216, INDIA
Phone:+91-20-6731-3400
<http://www.nitta.co.in>

NITTA CORPORATION KOREA OFFICE

Room710, 7F, ShinhanDM Bldg. Mapo-daero 25, Mapo-gu, Seoul, Korea
Phone:+82-2-3274-1252 Fax:+82-2-3274-1253
<http://www.nitta.kr>

NITTA INDUSTRIES EUROPE GmbH

Hansaallee 201, 40549 Dusseldorf, Germany
Phone:49-211-537535-0 Fax:+49-211-537535-35
<http://www.nitta.de>

NITTA CORPORATION OF SINGAPORE PTE LTD

120 Lower Delta Road, #05-07/08
Cendox Centre, Singapore 169208
Phone:+65-6438-8738 Fax:+65-6438-8793
<http://www.nitta.com.sg>
<Thai Liaison Office>Phone:+66-9-0654-9717
<Indonesia Liaison Office>Phone:+62-878-2292-5633

TAIWAN NITTA FILTER CO.,LTD.

Headquarters: Chia Hsin Building 10FL Room No. 1005, 96 Chung Shan North Road Section 2, Taipei, Taiwan, R.O.C.
Phone:+886-2-2581-6296 Fax:+886-3-469-0260
<http://www.nitta.com.tw>

NITTA BRASIL

Rua Francisco Mommenshon, 50B, Galpão 02
Laranjeiras, Caieiras, São Paulo, Brazil
Phone/Fax:+55-11-4441-2922
<http://www.nitta.com.br>

CONNECT CONVEYOR BELTING INC.

405 Industrial Drive Unit 3-8, Milton, Ontario Canada L9T 5B1
Phone:+1-905-878-5552 FAX:+1-905-878-0344
<http://www.connectbelting.com/>

The specification is subject to change for improvement without notice.

18051000U



Belts for Textile Industries

NITTA CORPORATION

4-4-26 Sakuragawa Naniwa-ku, Osaka 556-0022 Japan
Phone: +81-6-6563-1225 Fax: +81-6-6563-1242
<https://www.nitta.co.jp>



NITTA CORPORATION OF AMERICA

7605 Nitta Drive, Suwanee, GA 30024, U.S.A.
Phone: +1-770-497-0212 Fax: +1-770-623-1398
<http://www.nitta.com>

NITTA CORPORATION OF HOLLAND B.V.

Berenkoog 25, 1822 B.H. Alkmaar, The Netherlands
Phone: +31-72-5622234 Fax: +31-72-5613238
<http://www.nitta.nl>

NITTA (SHANGHAI) MANAGEMENT CO., LTD

Room 2705, Shenggao International Building, No.137 Xianxia Road, Shanghai 200051 CHINA
Phone: +86-21-6229-6000 Fax: +86-21-6229-9606
<http://www.nitta-cn.com>

NITTA CORPORATION INDIA PVT. LTD.

Gat No 191, 192, and 193, Plot No B, Village Vadhu Khurd, Taluka Haveli Dist Pune-412216, INDIA
Phone: +91-20-6731-3400 Fax: +91-20-6731-3401
<http://www.nitta.co.in>

NITTA CORPORATION KOREA OFFICE

Room 710, 7F, ShinhanDM Bldg, Mapo-daero 25, Mapo-gu, Seoul, Korea
Phone: +82-2-3274-1252 Fax: +82-2-3274-1253
<http://www.nitta.kr>

TAIWAN NITTA FILTER CO. LTD.

Headquarters: Chia Hsin Building 10FL Room No. 1005, 96 Chung Shan North Road Section 2, Taipei, Taiwan
Phone: +886-2-2581-6296 Fax: +886-3-469-0260
<http://www.nitta.com.tw>

NITTA INDUSTRIES EUROPE GmbH

Heerdter Lohweg 35, 40549 Dusseldorf, Germany
Phone: 49-211-537535-0 Fax: +49-211-537535-35
<http://www.nitta.de>

NITTA CORPORATION OF SINGAPORE PTE LTD.

120 Lower Delta Road, #05-07/08
Cendex Centre, Singapore 169208
Phone: +65-6438-8738 Fax: +65-6438-8793
<http://www.nitta.com.sg>
<Liaison Office> Indonesia, Vietnam

NITTA CORPORATION (THAILAND) LIMITED

7/472 Moo 6, Tambol Mabyangporm, Amphur Phluakdaeng,
Rayong Province 21140, THAILAND
Phone: +66-38-018-301 Fax: +66-38-018-304
<http://www.nittathai.com>

NITTA BRASIL

Rua Francisco Mommenshon, 50B, Galpão 02
Laranjeiras, Caeiras, São Paulo, Brazil
Phone/Fax: +55-11-4441-2922
<http://www.nitta.com.br>

CONNECT CONVEYOR BELTING INC.

405 Industrial Drive Unit 3-8, Milton, Ontario Canada L9T 5B1
Phone: +1-905-878-5552 FAX: +1-905-878-0344
<https://www.connectbelting.com>



NITTA CORPORATION

The specification is subject to change for improvement without notice.

1910500U

Product Specifications

※All belt types listed below have antistatic properties except for KSG-250

Category	Belt Type	Thickness (mm)	Surface (Top/Bottom) ※1	Color (Top/Bottom)	Tension Member ※2	Minimum Pulley Diameter (mm)	Tensile Force for standard Elongation (N/mm) ※3	Standard Elongation (%)	Recommend Elongation Range (%)	Temperature Range (°C)	Maximum length (m)	Card	Draw Frame	Ring Spinning	OE Spinning	Winding	TFO	DTY	Covering	Cleaner	Circular Knitting	Features	Skiver Splice	Finger Splice	Belt Type	Category	
PolyBelt	TFL-7S	2.4	NBR/NBR	Dark Blue/Gray	PA	75	15.0	2	1~3	-20~+80	105		●				●		●	●		Low Noise, Excellent Durability	●		TFL-7S	PolyBelt	
	TFL-10S	2.6	NBR/NBR	Dark Blue/Gray	PA	100	19.5	2	1~3	-20~+80	105 ⁴	●	●		●		●		●				●		TFL-10S		
	TFL-12S	2.85	NBR/NBR	Dark Blue/Gray	PA	125	24.5	2	1~3	-20~+80	105	●			●		●						●		TFL-12S		
	TFL-15S	3.1	NBR/NBR	Dark Blue/Gray	PA	150	30.0	2	1~3	-20~+80	105			●	●		●	●						●			TFL-15S
	TFL-18S	3.35	NBR/NBR	Dark Blue/Gray	PA	175	34.0	2	1~3	-20~+80	105			●				●						●			TFL-18S
	TFM-15S	3.7	NBR/NBR	Dark Blue/Gray	PA	150	30.0	2	1~3	-20~+80	105			●				●						●			TFM-15S
	L-500	1.55	NBR/NBR	Blue/Black	PA	50	7.5	2	1~3	-20~+80	105	●	●										Stable Coefficient of Friction, Abrasion Resistance, Excellent Durability	●			L-500
	LA-750S	2.25	NBR/NBR	Blue/Blue	PA	75	15.0	2	1~3	-20~+80	105										●			●			LA-750S
	L-1000S	2.45	NBR/NBR	Blue/Black	PA	100	19.5	2	1~3	-20~+80	105	●		●										●			L-1000S
	M-1000S	3.0	NBR/NBR	Blue/Black	PA	100	19.5	2	1~3	-20~+80	105			●					●					●			M-1000S
	MA-1500S	3.5	NBR/NBR	Blue/Blue	PA	150	30.0	2	1~3	-20~+80	105							●	●					●			MA-1500S
	M-1000GS	2.6	NBR/NBR	Blue/Black	PA	100	19.5	2	1~3	-20~+80	105 ⁴													●			M-1000GS
	MB-1000GSR	2.6	NBR/NBR	Black/Black	PA	100	19.5	2	1~3	-20~+80	105 ⁴												●		MB-1000GSR		
	IRS-6S	1.35	NBR/NBR	Green/Black	PA	60	11.5	2	1~3	-20~+80	105											●	Specially Developed for Pneumatic Cleaner	●			IRS-6S
IR-500	1.3	NBR/NBR	Green/Green	PA	40	3.8	1	1~3	-20~+80	105											●	For Circular Machine, High Friction	●		IR-500		
KSG-250	0.85	NBR/PA	Green/White	PA	20	3.0	2	1~3	-20~+80	105			●									Spindle Tape	●		KSG-250		
PolySprint	TFL-15E20	2.0	NBR/NBR	Dark Blue/Black	PE	40	15	1	0.5~2	0~+60	200	●	●	●								Less Power Consumption Easy to Make Endless, Low Noise, Shorter Take-up	●		TFL-15E20	PolySprint	
	TFL-15E25	2.5	NBR/NBR	Dark Blue/Black	PE	40	15	1	0.5~2	0~+60	200			●										●			TFL-15E25
	TFL-22E26-2	2.6	NBR/NBR	Dark Blue/Black	PE	50	22	1	0.5~2	0~+60	200			●	●			●						●			TFL-22E26-2
	TFL-22E26C-2	2.6	NBR/NBR	Dark Blue/Gray	PE	50	22	1	0.5~2	0~+60	200							●		●				●			TFL-22E26C-2
	TLA-30E30-2	3.0	NBR/NBR	Dark Blue/Dark Blue	PE	70	30	1	0.5~2	0~+60	100							●	●					●			TLA-30E30-2
	TA-S6	0.9	TPU/TPU	Blue/Black	Knit	25	0.7	5	5~8	-20~+60	100	●															●
CFTG	CFTG-40F	3.0	NBR/NBR	Blue/Blue	AR	100	40	0.5	0.2~0.5	-10~+60	200			●				●	●			Less Power Consumption Easy to Make Endless, Low Noise, Shorter Take-up	●		CFTG-40F	CFTG	
	CFTG-60F-3.9	3.9	NBR/NBR	Blue/Blue	AR	150	60	0.5	0.2~0.5	-10~+60	200			●				●	●				●		CFTG-60F-3.9		
SEB	SE-A-PB	1.2	NBR/NBR	Black/Black	PE	15	7.4	1	0.5~1	-20~+80	4.525 ⁵						●					Seamless	-	-	SE-A-PB	SEB	
	SE-B-PB	1.4~1.6	NBR/NBR	Black/Black	PE	25	14.7	1	0.5~1	-20~+80	4.525 ⁵		●						●				-	-	SE-B-PB		
	SE-D-PB	1.7	NBR/NBR	Black/Black	PE	35	29.4	1	0.5~1	-20~+80	4.525 ⁵		●						●				-	-	SE-D-PB		

*1 Depending on the application, top and bottom covers can be reversed.
 *2 PE : Polyester PA : Polyamide AR : Aramid
 *3 Tensile Force is measured after running 200 hours in internal test.

*4 Please ask us if the belt length over 105m needed.
 *5 SEB length depends on the mold.

The NITTA Advantage - Innovative Products and Solutions



PolyBelt™

Super-strong polyamide core, extended-life skived joining, high operating duty cycles

- High Strength, Long Life**
 High flexibility and rugged design for heavy-duty applications. Polyamide core accommodates shock loads, and wide choice of covers provide abrasion resistance, giving long, dependable service.
- Electrically Conductive**
 Materials with anti-static properties are used in specific layers to provide permanent conductivity, eliminating build-up of electro-static charges. Selected materials are not susceptible to oil contamination.
- Environmental Resistance**
 Selected materials are not susceptible to oil contamination.

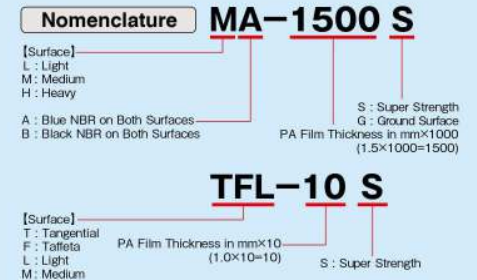
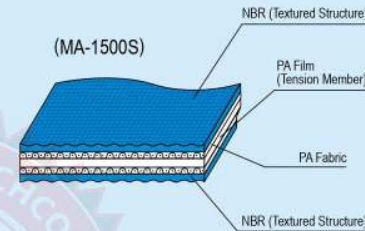

PolySprint™

Finger-spliceable, easy installation, high-strength polyester core

- Ease of Joining**
 A single action Nitta cutter eliminates the tedious task of multiple cuts that can lead to mismatched and non-aligned joints. Finger-splice joints are completed without adhesive.
- Dimensional Stability**
 Polyester fabric used as tension member provides high dimensional stability. Selected materials are temperature and humidity tolerant.
- Abrasion Resistance**
 Friction resistant covers and fabric are exclusively designed for textile machinery.
- Less Power Consumption**
 PolySprint's flexibility enables machines to run more efficiently, reducing power consumption.

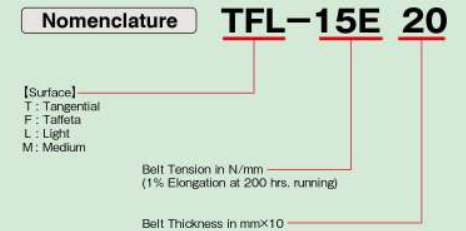
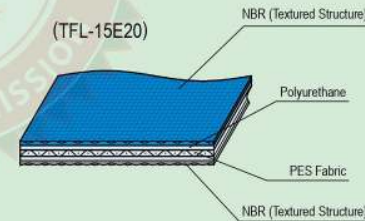

SEB™ (Super Endless Belt)

- Seamless**
 Splice free belts made by molded forming with excellent dimensional stability.
- Excellent flexibility, bending resistance and abrasion resistance**
 Excellent flexibility, long flex life and abrasion resistance can be expected even with power transmission and carrying equipment using very small pulleys.
- High rotation accuracy**
 High rotation accuracy is available as pitch line is stable.

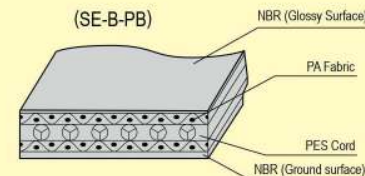

Splicing Tools (PolySprint™ • PolyBelt™)

Splicing Tools for PolySprint™

**Quick and Easy Endless
(No Experience Required)**

**Finger Joint
(No Adhesive Needed)**

PolySprint™

PolySprint tools make replacing broken belts quick and easy, with minimal disassembly of the machine.



● Finger Puncher

Type	Appearance	Features	Max. Width (mm)	Max. Thick. (mm)	Size (mm)			Wt. (kg)	Finger Length × Pitch
					Width	Length	Height		
FP120-10-50		Precise indexing system	50	6.0	180	600	250	9.0	120×10
FP120-10-100		Precise indexing system	100	6.0	230	610	250	10.5	120×10

● Heating and Cooling Press

Type	Appearance	Features	Marking	Max. Width (mm)	Max. Thick. (mm)	Size (mm)			Wt. (kg)	Finger Length × Pitch	Power	Temp. (°C)	
						Width	Length	Height					
NPS-1210-1		Automated heating and cooling press	PS E	100	6.0	230	320	180	9.5	120×10	100V	~200	
NPS-1210-2											CE		200V
NPS-1205H1		Quick finishing just in 10 minutes.	PS E	50	6.0	Press Body 165	320	115	3.6	70×10 120×10	100V	~210	
NPS-1205H2											CE		200V
NPS-1205C											-		-

● Other Tools

Type	Appearance	Features
Presetter		Guide rails to hold joint straight when pressing
Clamp (2 Pieces)		Clamps for holding presetter together when pressing

Splicing Tools for PolyBelt™

PolyBelt™

Nitta provides well-made, reliable tools for effective and efficient fabrication of our belts.

● Poly Skiver

Type	Appearance	Features	Max. Width (mm)	Max. Thick. (mm)	Size (mm)			Wt. (kg)	Power
					Width	Length	Height		
PS153		PolyBelt skiver for making skived ends. Highly reliable and widely accepted.	150	3.0	400	380	435	33.0	100V or 200V

● Poly Press

Type	Appearance	Features	Marking	Max. Width (mm)	Max. Thick. (mm)	Size (mm)			Wt. (kg)	Power	Temp. (°C)
						Width	Length	Height			
PP051		PolyBelt press for skived joining. Lightweight, easy to use and well-regarded in the industry.	PS E	50	2.5	112	160	90	1.3	100V or 200V	110
PP103		PolyBelt press for skived joining. Reliable, easy to use and well-regarded in the industry.	PS E	100	5.0	140	295	150	3.1	100V or 200V	

Sonic Tension Meter U-508



Measurement of tension has depended greatly on the measurer's instinct, sometimes with very subjective results. Now, the sonic belt tension meter allows anyone to measure tension easily and correctly. Acoustic waves (natural frequency) generated by a belt are captured by the meter's sensor, and a digital processor uses the reading to calculate tension to a high degree of accuracy. The precise results are displayed on-screen.



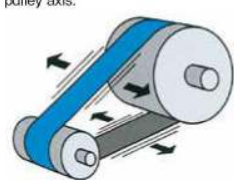



TROUBLESHOOTING & SOLUTIONS

Issue	Cause	Solution
On all spindles, the required revolution is not obtained. 	Belt slippage occurring on the motor drive pulley.	The belt tension should be increased.
	Oil adhering to the belt.	Wipe away the oil which has adhered to the belt surface. Replace the belt with a new one if it is not possible to clean it.
	The diameter of some pulleys is not correct.	Replace the pulley with one suitable for the spindle revolution required.
	Belt slippage occurring on motor-drive belt or the belt driving the tangential-drive pulley.	Increase belt tension. Wipe away the oil which has adhered to the belt surface.
	Yarn's "Balloon-load" exceeds the transmitted power of the belt.(In this situation, the belt slips on the drive pulley or spindle wharves.)	Check the belt tension and or the intruding depth of the contact pulley.
On the slack side, the required revolution is not obtained.	The pressure load of the belt against the spindle wharves on the slack side is insufficient.	Increase the belt tension. Adjust the intruding depth of the contact pulley (thus increasing the spring force).
	Yarn particles are wound up in the spindle wharves and as a result, the spindle load is increased.	Remove the yarn particles.
	Something is wrong with the bearing rotation.	Replace the bearing or the spindle with a new one.
Incessant noise.	Some foreign materials have adhered to the belt surface.	Wipe away the foreign materials. Grind the belt surface lightly with fine sand paper.
	Some foreign materials have adhered to the spindle wharves.	Wipe away the foreign materials.
Intermittent noise.	The spliced section of the belt is beginning to tear.	Rejoin the spliced section. Immediately replace the belt with a new one if too much damage has occurred.
	A section of the belt surface is deformed.	Check the cause. Take appropriate corrective action if such deformation is caused by abnormal abrasion of the belt. Replace the spindle or the belt if the belt is unusually heated due to an issue with spindle revolution and is burned at the time of belt stoppage.
Noise at certain places(such as at spindles).	Something is wrong with the bearing rotation.	Replace the bearing.
	Belts are bumping or rubbing somewhere.	Adjust the belt tracking.
Belt tends to deviate in either upper or lower direction from the proper tracking position.	Something is wrong with the belt tracking.	Adjust the belt tracking by adjusting contact pulleys or guide pulleys.
Belt tends to run zigzag against the pulley axis. 	Something is wrong with the belt tracking.	Adjust the belt tracking by adjusting contact pulleys or guide pulleys.
	Spindles are not securely fixed.	Check the bearings.
	Pulley has a small crown.	Make pulley crown larger.
	Spindle wharves, contact pulleys or other pulleys are not horizontally aligned.	Align pulleys properly.

For Safe Use of Products

※ Before use, carefully read and follow the safety precautions below.

- For safe use, this instruction manual and the product use various symbols and signal words.
- After fully understanding their meanings, read the safety precautions and follow the instructions.
- Improper use ignoring the symbols and the signal words may result in the following risks.

Symbol and Signal Word	Severity of Risk
 DANGER	Indicates matters that may lead to imminent risk of death or serious injury if ignored or incorrectly handled.
 WARNING	Indicates matters that may lead to death or serious injury if ignored or incorrectly handled.
 CAUTION	Indicates matters that may lead to injury and physical damage if ignored or incorrectly handled.
 Signs	Meaning of Signs Indicates actions that you must not do when handling the products.
 Prohibition	
 Mandatory Action	

1. Function and Performance

-  **DANGER** 
 - Do not use the belt as hoisting or towing equipment.
-  **WARNING**
 - Do not use the belt beyond the acceptable ranges specified in the Catalogue.
 - When fire and malfunction of the control device are expected due to static electricity generating in the transmission device, use an antistatic belt. Set a neutralization apparatus in the transmission device.
 - Do not use the belt for conveying unpackaged food.

2. Storage and Shipping

-  **WARNING**
 - Keep fire away.
 - Belt is combustible; do not store or use it near fire or a high-temperature heat source.
 - When storing heavy belts, fix them by appropriate jigs or stoppers to prevent falling or rolling.
-  **CAUTION**
 - When storing and shipping the belts, do not distort them excessively.
 - Store the belts in a well-ventilated, low-humidity place free from direct sunlight. The recommended storage temperature is -10 to +30°C.
 - Store the belts in the shipping packages.

3. Installation and Daily Use

-  **DANGER** 
 - Be sure to put a safety cover over the rotating part including the belt; hair, gloves or clothes may get caught in the belt pulley.

- Before maintenance, inspection or replacement, be sure to turn off the switch and check that the machine stops.

-  **WARNING**
 - When cleaning the belt, do not use chemicals harmful to humans.
-  **CAUTION**
 - After replacing the belt with a new one, perform a test operation to adjust tension, elongation rate and operation.
 - Do not attach the belt forcibly; use a motor slide, a tension pulley or a special pulling device.
 - When abnormal noise, snaking, deviation, slipping, etc. occur, stop the belt immediately for inspection.

4. Installation, Endless Processing, etc.

-  **WARNING**
 - When using solvent or adhesive, fully ventilate the workplace. Keep fire away.
-  **CAUTION**
 - Perform endless joining of belts by using the materials, the methods and the procedures specified by Nitta.

5. Handling Used Belts

-  **WARNING**
 - Do not leave the belts near fire.
-  **CAUTION**
 - Do not burn used belts; harmful gasses may be generated.
 - Lawfully dispose of the used belts as industrial waste.

THE EXCELLENCE OF NITTA TECHNOLOGY

Nitta Corporation turns dreams into reality. Our combination of dynamic imagination and creativity with an organic corporate structure enables us to cover a wide-range of products from the most advanced semiconductors and space development to everyday commodities. We are continuously seeking new products and new frontiers. This new technology, not immediately obvious to the naked eye, is vital to the continued growth of every industry. Our objective is to develop the extraordinary. Then to translate the extraordinary into the everyday.

BELTING PRODUCTS

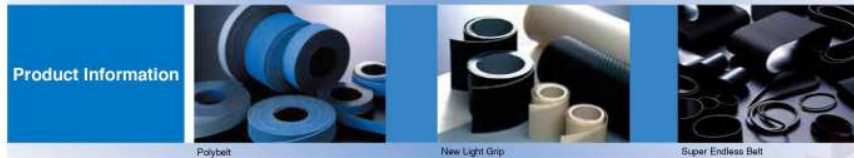

The Nitta tradition of manufacturing belting products began in 1888, with the power transmission leather belts that were the first of their kind to be produced in Japan. Today, our power transmission and conveyor belts continue to be utilized in a wide variety of machines. By meeting society's needs with products including high-function and high added-value belts that convey power and objects more rapidly and reliably than ever, Nitta uses its technical capabilities to make a contribution to our society.

CONVEYOR PRODUCTS



Conveyors, which transport a variety of products from one station to another, must be efficient, capable of making the most of a limited amount of space to convey objects smoothly without any human aid. At Nitta, where we carry out the design-to-construction process for production-line conveyor systems, we use

our technical know-how to promote conveyance speed and safety, and also offer advice on issues including the placing of conveyors to accommodate machines or installation environment. In a world where manufacturing and product logistics are becoming more important than ever, let us at Nitta provide the ideal solutions to your conveyor product needs.

ENGINEERED RUBBER PRODUCTS



Skyscrapers, intelligent buildings and a lattice-like pattern of highly ordered expressways make city life more comfortable. It is essential for these utilities to be safe and durable as well as aesthetically pleasing. Nitta is providing various kinds of reliable and easily maintained engineered rubber products

such as construction materials and precision molding. They are made from high quality rubber with our own unique and special technology. Cities are full of amenities, and we are supporting the safety and comfort of city life by supplying high quality products.

HOSE & TUBE PRODUCTS

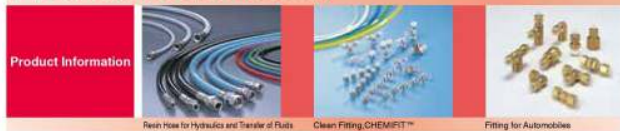

In the world of industry, there are many situations requiring hydraulic or pneumatic energy transmission or the transfer of fluids and as a pioneer in the field of resin hoses and tubes, Nitta is proud of its role in making this possible. Through our technological innovations and by responding to ever-diversifying needs for

enhanced functions, we have succeeded in fusing new materials and technologies to create a wide variety of products. At Nitta, we will continue to offer new solutions to expand the possibilities of next-generation technology.

AIR FILTRATION PRODUCTS



New technology innovation is required everyday in high-technology industries. Nitta has been contributing significantly to the fields of semiconductor production and nuclear application by using unique air filter systems to create totally dust-free environments. These fields are at the forefront of our era. Nowadays, our filter systems are broadly used not only these fields but also PFD (Flat panel display), pharmaceuticals, foods, office buildings, and so on. Furthermore, we are developing ecological products which aim to reduce industrial waste and save resources, energy and costs. We are creating comfortable and dust-free environments, as well as protecting the earth and the natural environment, giving consideration to all environments and the realization of a perfect ecosystem.

MECHATRONIC PRODUCTS



These are the newest products for automated production lines by our connecting technologies. Industrial robots have a key role in the automation line, in response to a variety of applications required by the end of the industrial robot's arm we will meet the demands of our customers.

TACTILE SENSOR PRODUCTS



0.1mm thin film sensor supports the quality improvement and product development needs of our customers. In various fields, such as industry and medical, our thin film sensor shows the pressure distribution on the contact area in real time, and contributes to advanced quality control, prompt development and high customer satisfaction.

THERMOSENSITIVE ADHESIVE TAPE



Intellim™ Tape is an adhesive tape utilizing a special polymer which responds to temperature to become adhesive or non-adhesive. As an industrial-use tape, Intellim™ Tape brings labor-saving efficiency to work operations, and its ability to be reusable under the right conditions helps promote resource conservation and cost savings.

WIRELESS COMMUNICATION DEVICES

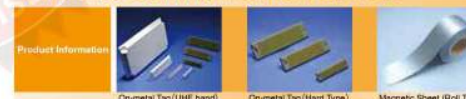

By integrating our original rubber and resin technologies, we have developed high-performance magnetic sheets for wireless communication of mobile equipment as well as RFID tags (non-contact IC cards).

NITTA GROUP

GATES UNITTA ASIA COMPANY

Integrated Systems Enhance Quality

Conveyance and transmission systems harness the power in products. For the automobile and beyond, Gates Unitta Asia (GUA) is the leader in power transmission.



NITTA GROUP

NITTA HAAS INCORPORATED

A Well Sharpened Future is Just Around the Corner

Polishing Systems, which are progressing toward "Nano-Structures." The world of human technology that keeps seeking "Beauty and Difference."

SUPER ENDLESS BELT
SEB™

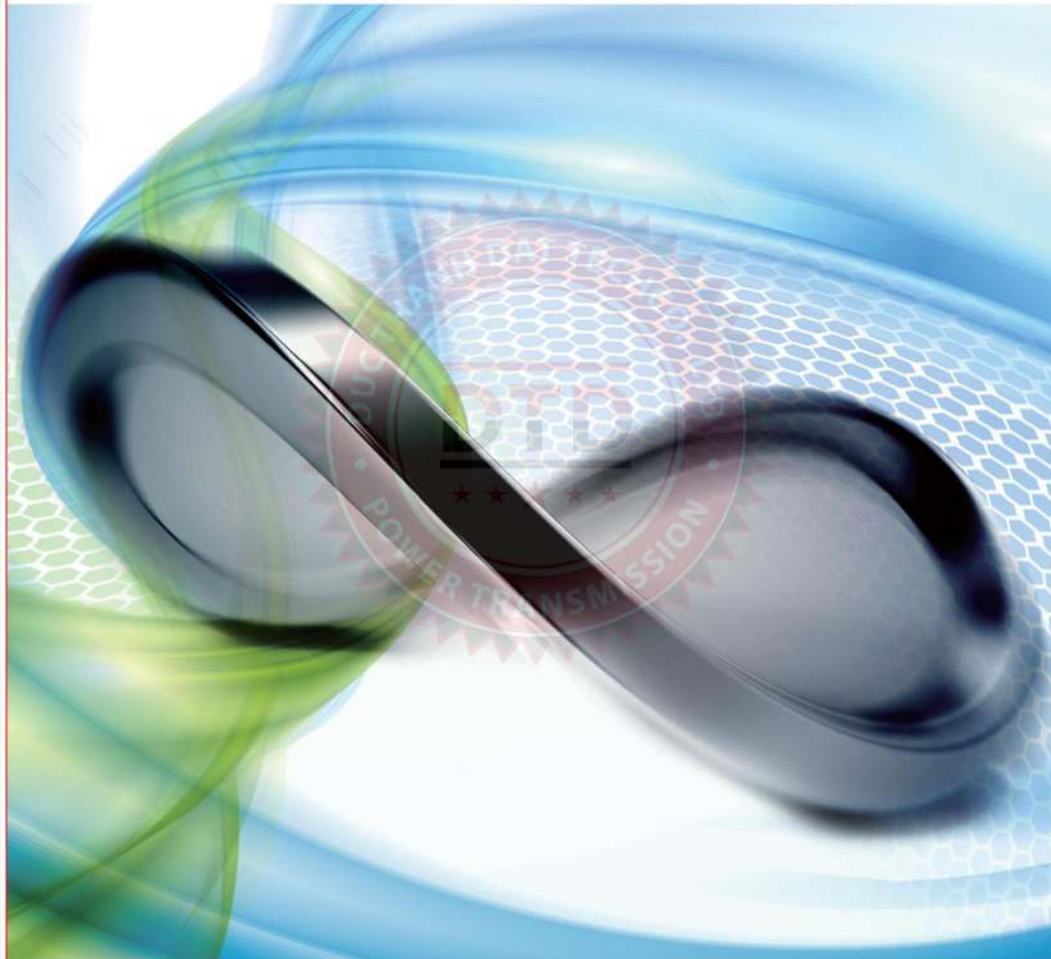

NITTA CORPORATION

Since entering the new century, automation has been progressing remarkably. To develop OA (Office Automation), FA (Factory Automation) and SA (Store Automation), further sophisticated equipment is needed.

Nitta Corporation has been continuously researching and developing SEB™ (Super Endless Belt) since its appearance on the market, giving first priority to customer satisfaction and meeting the demands of the times. As a result, the superior performance of SEB has produced high reliability.

In 1996, Nitta obtained ISO 9001 certification and is ready to supply products that fit the increasingly globalized world, through the appropriate quality assurance system. We provide various types of belts to meet any of your demands.



Excellent Features

1 Seamless Belt

Molded seamless belt with excellent dimensional stability

2 High Revolution Accuracy

Stable pitch line of the seamless belt ensures high revolution accuracy.

3 Compatible with Small Pulley Diameter

Thin, highly flexible, bendable, abrasion resistant and durable; SEB provides superior performance when used for precision power transmission equipment and conveyors with small pulleys.

4 High Oil/Chemical Resistance

Highly resistant to almost all chemicals
Suitable for a wide range of power transmission and conveyance

5 High Environmental Resistance

High resistance to environment including cold, heat and ozone
Suitable for a wide range of uses

6 Maintenance Free

Excellent tension retaining properties
Maintenance (belt replacement, etc.) unnecessary for a long time

7 A Variety of Types

You can select a belt appropriate for your use from a variety of belts with different surface materials, tension members, structures, etc.

SUPER ENDLESS BELT

Table of Contents

Excellent Features	1
Major Applications	2
Belt Structure and Properties	3
List of Products	4 to 5
Types, Properties and Inner Peripheral Length	
Pinching Conveyor Belt N Series	6 to 7
Conveyor and Low-Load Power Transmission Belt G15 Series	8 to 9
Conveyor and Low-Load Power Transmission Belt G 30 Series	10 to 11
Conveyor and Medium-Load Power Transmission Belt F50 Series	12 to 13
Conveyor and Medium-Load Power Transmission Belt F100 Series	14 to 15
Medium-Load Power Transmission Belt XA/A Series	16 to 17
High-Load Power Transmission Belt B/D/GS Series	18 to 19
High-Temperature Conveyor and Low-Load Power Transmission Belt H50 Series	20 to 21
Selecting Belt	
Selecting Conditions/Procedures	22
Selecting Type/Structure	23
Design Materials	
Transmitted Power Correction Factor (K_1) According to Load Change	24
Belt Type Selection Diagram and Traction Coefficient (λ)	25
Calculation for Selecting Belt	26
Design Calculation	27 to 28
Formulas and Conversion Table	29
Calculating Belt Inner Peripheral Length	30
Belt Inner Peripheral Length Nomograph	31
Flat Pulley and Recommended Shape of Pulley	32 to 33
For Correct Use (Precautions for use)	34 to 35
Troubleshooting	36
For Safe Use of Products	37

Suitable for Every Place and Every Use

Major Applications

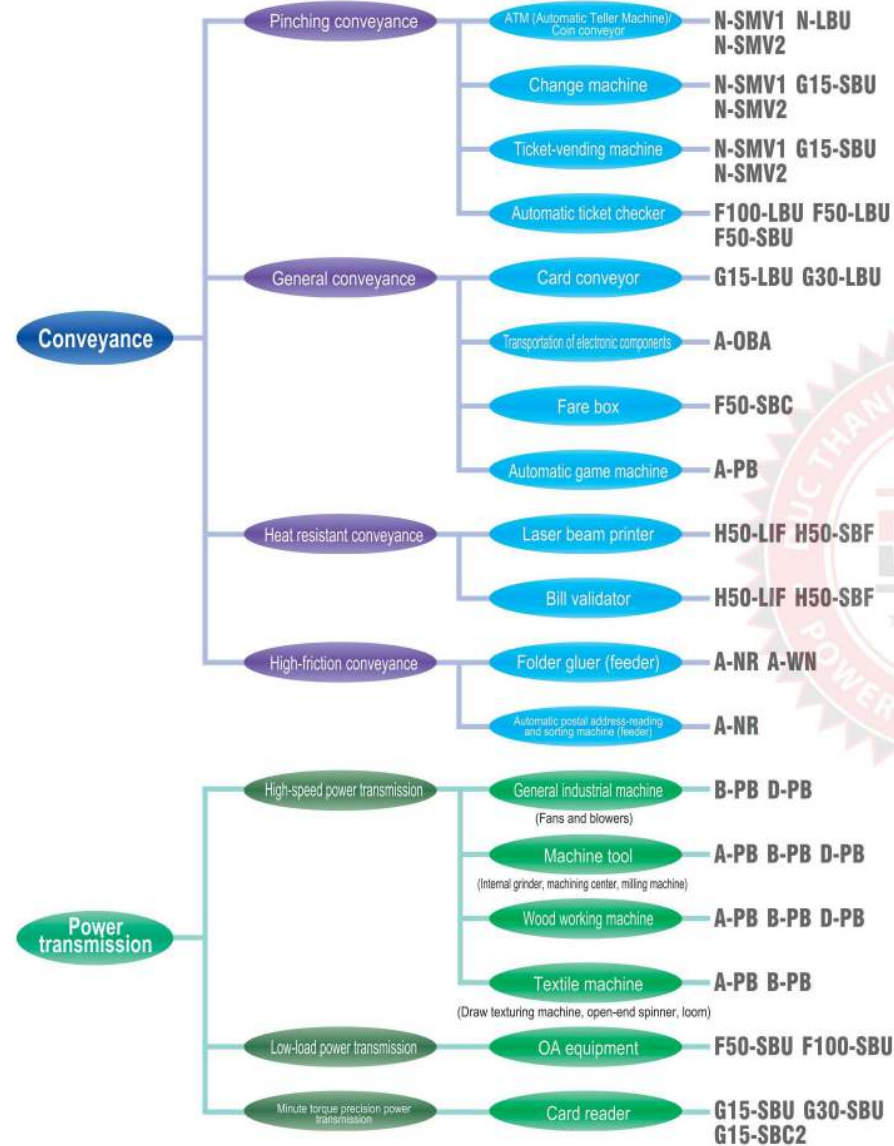

Belt Structure and Properties

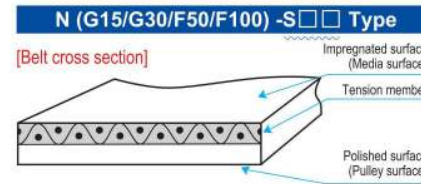

[Features]

- [Conveying paper sheets pinched between belts]
- The tension member is on the impregnated surface side; there is not much difference between the belt speed and the media speed.
 - The facing tension members are close to each other; even in a winding layout, there is not much difference among the belt speeds.
 - Due to little difference among the speeds, sliding resistance (load caused by the pinching layout) is low, thus reducing power consumption of the machine.

[Labeling]

Example: **G15 - SBU 15^W × 300^L × 0.65^T**

Series Structure Width (mm) Inner peripheral length (mm) Thickness (mm)
 [Un necessary for the standard specification]

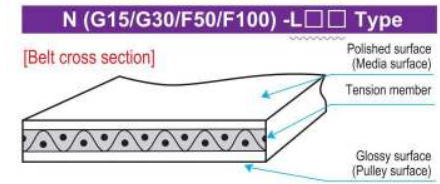

[Features]

- [Conveying hard cards pinched between belts]
- When a card contacts with a belt at a sharp angle (on a pulley) during carrying-in/out, damage to the tension member is absorbed by the surface rubber.

Rubber Properties by Belt Types

Belt Type	Properties					
	Crack resistance	Abrasion resistance	Oil resistance	Ozone resistance	Heat resistance	Antistatic property
N-SMV1.V2	●	●	●	●	▲	●
N-LBU	●	●	●	●	▲	○
G15, G30 -□BU	●	●	●	●	▲	○
F50 -□BC	●	○	○	●	○	●
F100 -□B	○~▲	●	●	▲	▲~○	●
H50	○	▲	●	●	●	×
XA, A, B, D -PB	○~▲	●	●	▲	▲~○	●
A -PC	●	○	○	●	○	●
A -OBA	○~▲	●	●	▲	▲~○	●
B -PSS	○~▲	●	●	▲	▲~○	●
GS -OC	●	○	○	●	○	●
A -NR [High friction against the conveyor rollers]	×	▲ ※1	×	×	×	○
A -WN [High friction against the conveyor rollers]	×	▲ ※1	×	×	×	×

※1 Excellent as a feeder belt



● Especially excellent ○ Excellent ▲ Examination needed depending on use conditions × Poor

A variety of products available to meet your

needs accurately and efficiently

List of Products (SEB™)

 Approximate range of use

Major Applications	Tension member		Series	Type	Properties	Recommended elongation rate (%)	Breaking Strength (N/mm width)	Approximate Range of Standard Belt Transmitted Power (per 10 mm width)			Page
	Structure	Material						1	10	10 ²	
 	High-stretch seamless knit fabric	Polyester	N	LBU	● High stretch and high precision conveyance	5.0	11.8	1.47N	4.12N		6 to 7
				SMV1			6.86				
				SMV2			9.31				
	Seamless woven fabric	Polyester	G15	SBU	● High precision conveyance ● Minute torque power transmission ● Precision power transmission	2.0	8.83	2.45N	6.86N		8 to 9
				LBU							
				SBC1							
				SBC2							
				LBC							
				SB							
			LB								
G30			SBU	● High-precision conveyance ● Small torque power transmission ● Precision power transmission	2.0	17.7	5.00N	13.6N		10 to 11	
			LBU								
			SBC1								
	SBC2										
Polyester	F50	● Low-load power transmission ● High-speed conveyance	2.0	24.5	8.24N	22.75N		12 to 13			
									LBU		
									SBC2		
									LBC		
									SB		
	LB										
	F100	● Low-load power transmission ● High-speed conveyance	2.0	39.2	13.24N	36.38N		14 to 15			
									LBU		
									SBC2		
									LBC		
SB											
LB											
Cord	Polyester	XA	PB	● Low-torque, high-speed power transmission	1.0	29.4	12.36N	34.12N		16 to 17	
											A
		PC									
		OBA									
		NR	0.5	6.18N	34.12N						
	WN	0.5									
	Glass fiber	GS	OC	● High modulus ● Sliding conveyance	0.3	216	24.81N	68.25N		18 to 19	
B											PB
Heat resistant, lightweight conveyance and power transmission	Seamless woven fabric	Special heat-resistant fiber	H50	LIF	● High-temperature conveyance ● High-temperature, low-torque power transmission	2.0	24.5	8.24N	22.75N		20 to 21
				SIF							
				LB F							

Pinching Conveyor Belt

N Series

Feature: High-stretch, high-precision conveyor belt; easy installation available even in a complicated layout
 Use: Pinching conveyance for ATM and ticket-vending machines
 Cross Section

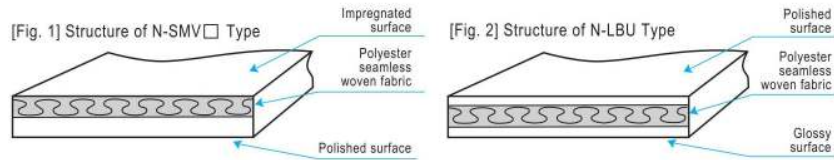

Types and Properties

Item	N-SMV1	N-SMV2	N-LBU	
1 Structure	Fig. 1	Fig. 1	Fig. 2	
2 Available width (mm)	8~200	8~200	8~200	
3 Standard thickness (mm)	0.65	0.65	1.0	
4 Rubber material	Millable urethane	Millable urethane	Millable urethane	
5 Surface figure	Impregnated surface	Impregnated surface	Polished surface	
6 Pulley surface figure	Polished surface	Polished surface	Glossy surface	
7 Weight	8	8	12	
8 Breaking strength (N/mm width)	6.86	9.31	11.8	
9 Standard elongation rate (%)	5.0	5.0	5.0	
10 Axial load at the standard elongation rate under stable conditions (N/mm width)	0.88	1.18	0.98	
11 Friction coefficient	Top surface (against paper sheet)	0.3 to 0.6	0.3 to 0.6	0.4 to 0.8
	Bottom surface (against SUS)	0.4 to 0.8	0.4 to 0.8	0.5 to 1.0
12 Minimum pulley diameter (mm)	φ8	φ8	φ10	
13 Operating temperature range	-20 to +60	-20 to +60	-20 to +60	

Standard Dimensional Tolerance

(1) Width (mm)		(2) Thickness (mm)	
Width	Tolerance	Thickness	Tolerance
8 or more and less than 11	±0.3	0.6 or more and less than 0.8	±0.05
11 or more and less than 21	±0.5	0.8 or more and less than 1.0	±0.06
21 or more and less than 101	±1.0	1.0 or more	±0.10
101 or more	±1.5		

(3) N-SMV1/SMV2 (Thickness: 0.65 mm): List of Inner Peripheral Lengths (mm)

Less than 200			200 or more and less than 300			300 or more and less than 500			500 or more and less than 800			800 or more and less than 1100		1100 or more	
Tolerance: ± 2			Tolerance: ± 3			Tolerance: ± 4			Tolerance: ± 6			Tolerance: ± 7		Tolerance: ± 0.8 %	
80.0	120.0	155.0	201.0	248.0	300.0	362.0	425.0	503.0	593.0	724.0	804.0	1033.0	1108.0	1504.0	
82.0	123.0	156.0	202.0	249.0	301.0	367.0	426.0	505.0	595.0	734.0	820.0	1048.0	1123.0	1543.0	
84.0	125.0	160.0	204.0	251.0	304.0	371.0	427.0	510.0	600.0	740.0	835.0	1057.0	1143.0	1558.0	
86.0	127.0	161.0	205.0	252.0	305.0	372.0	429.0	519.0	604.0	747.0	854.0	1066.0	1149.0		
90.0	128.0	163.0	206.0	254.0	306.0	376.0	431.0	522.0	607.0	754.0	855.0	1072.0	1150.0		
93.0	129.0	164.0	208.0	256.0	309.0	381.0	437.0	529.0	614.0	756.0	856.0	1073.0	1171.0		
97.0	130.0	167.0	213.0	264.0	310.0	384.0	443.0	533.0	619.0	760.0	862.0	1078.0	1181.0		
100.0	132.0	168.0	214.0	267.0	313.0	388.0	447.0	536.0	630.0	765.0	873.0	1080.0	1198.0		
101.0	133.0	171.0	218.0	270.0	318.0	390.0	452.0	537.0	639.0	770.0	882.0	1088.0	1206.0		
103.0	135.0	173.0	222.0	272.0	320.0	391.0	454.0	542.0	642.0	775.0	883.0	1096.0	1213.0		
104.0	138.0	176.0	222.5	275.0	322.0	393.0	457.0	545.0	653.0	790.0	904.0		1238.0		
106.0	139.0	177.0	223.0	277.0	325.0	397.0	458.0	548.0	655.0		914.0		1259.0		
107.0	139.5	180.0	225.0	278.0	326.0	402.0	459.0	552.0	661.0		919.0		1270.0		
108.0	140.0	181.0	230.0	283.0	328.0	406.0	464.0	557.0	665.0		941.0		1279.0		
110.0	142.0	182.0	235.0	285.0	329.0	410.0	467.0	559.0	669.0		956.0		1309.0		
111.0	143.0	184.0	237.0	285.5	330.0	411.0	468.0	563.5	674.0		966.0		1317.0		
112.0	144.0	186.0	238.0	286.0	332.0	412.0	470.0	564.0	680.0		979.0		1341.0		
113.0	145.0	190.0	240.0	287.0	339.0	414.0	474.0	572.0	689.0		986.0		1356.0		
114.0	146.0	192.0	241.0	288.0	345.0	416.0	482.0	578.0	697.0		1001.0		1405.0		
115.0	149.0	193.0	243.5	290.0	349.0	420.0	493.0	583.0	700.0		1007.0		1425.0		
116.0	150.0	195.0	246.0	297.0	350.0	421.0	495.0	586.0	704.0		1022.0		1441.0		
117.0	151.0	199.0	246.5	299.0	352.0	423.0		589.0	711.0		1027.0		1457.0		
118.0	154.0		247.0		358.0	424.0		590.0	712.0		1029.0		1488.0		

(4) N-LBU (Thickness: 1.0 mm): List of Inner Peripheral Lengths (mm)

Less than 200			200 or more and less than 300			300 or more and less than 500			500 or more and less than 800			800 or more and less than 1100		1100 or more	
Tolerance: ± 2			Tolerance: ± 3			Tolerance: ± 4			Tolerance: ± 6			Tolerance: ± 7		Tolerance: ± 0.8 %	
82.5	121.0	160.0	201.5	252.5	300.0	365.5	427.5	506.5	597.0	716.5	809.0	1063.0	1102.0	1495.0	
84.0	121.5	162.5	203.5	254.0	302.5	371.0	428.5	508.5	599.5	728.5	824.5	1071.5	1113.5	1511.0	
86.0	125.0	164.0	205.0	255.0	303.0	374.0	429.0	514.0	604.0	738.5	840.0	1077.0	1128.5	1550.0	
88.0	127.5	166.0	207.5	257.5	304.5	375.0	430.0	523.0	608.0	745.0	859.0	1079.0	1149.0	1565.0	
93.0	129.0	167.0	208.5	259.5	307.0	376.0	433.0	523.5	611.0	751.5	859.5	1083.0	1155.0		
95.5	131.0	170.0	211.5	264.0	309.0	380.0	435.0	526.5	618.5	759.0	866.5	1085.5	1156.0		
96.5	132.5	171.0	214.5	266.5	310.0	385.0	441.0	533.0	623.5	764.0	878.5	1094.0	1177.0		
99.5	134.5	174.0	216.5	273.5	312.5	388.0	447.0	538.0	634.5	770.0	886.5		1187.0		
103.0	136.0	176.0	217.5	275.5	316.0	391.0	451.0	540.5	640.5	773.0	909.0		1204.5		
104.0	138.0	179.0	220.5	277.5	321.5	393.5	456.0	546.0	643.0	779.5	919.0		1214.0		
106.0	140.5	180.5	224.5	280.5	323.0	397.0	458.0	549.0	646.5	794.0	923.5		1219.5		
106.5	141.5	183.5	225.5	281.0	325.0	400.0	460.5	552.0	657.0		946.0		1244.0		
108.5	142.0	184.5	228.5	284.5	328.5	401.0	463.0	556.5	659.0		961.0		1265.0		
109.0	143.0	187.5	231.5	285.0	329.0	405.5	467.5	561.0	665.0		972.0		1276.0		
111.0	145.0	189.5	233.0	286.5	331.5	409.0	471.0	562.5	669.5		974.0		1285.0		
112.0	146.0	192.5	238.5	288.0	332.0	413.5	474.0	563.0	673.5		991.0		1315.5		
113.0	147.5	194.5	239.0	288.5	335.0	415.0	478.0	567.5	678.0		1007.0		1323.5		
114.5	149.0	196.0	241.5	290.0	342.0	416.0	486.0	568.0	684.0		1012.0		1347.0		
115.5	152.0	197.5	243.5	291.0	349.0	417.0	496.5	576.5	693.0		1027.0		1362.0		
116.0	153.0		247.0	295.0	353.0	419.0	499.0	582.0	701.0		1032.5		1412.0		
117.5	153.5		249.0		354.0	423.0		587.5	704.5		1034.5		1432.0		
119.0	156.5		249.5		355.0	425.0		590.0	709.0		1038.5		1447.0		
119.5	158.0		250.5		361.0	426.5		593.5	716.0		1053.5		1464.0		

* If you wish to order a product with a size other than the standard, consult us.
 * SEB is built to order; the minimum order quantity is one lot. For details, contact our agencies or our sales representative.

Conveyor and Low-Load Power Transmission Belt

G15 Series

Feature: This belt, which uses thin, polyester seamless woven fabric as a tension member, is applied to conveyance and low-load power transmission.
 Use: ATM, copy machine sorters, minute-torque precision power transmission, OA equipment, etc.

Cross Section

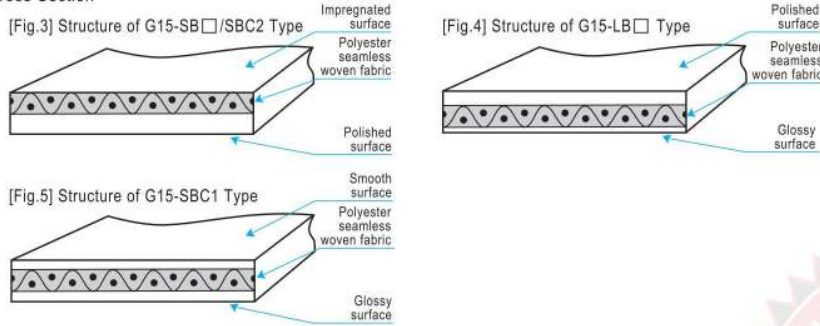

Types and Properties

Item	G15-SBU	G15-LBU	G15-SBC1	G15-SBC2	G15-LBC	G15-SB	G15-LB
1 Structure	Fig. 3	Fig. 4	Fig. 5	Fig. 3	Fig. 4	Fig. 3	Fig. 4
2 Available width (mm)	3 to 200	3 to 200	3 to 200	3 to 200	3 to 200	3 to 200	3 to 200
3 Standard thickness (mm)	0.65	1.0	0.43	0.6	1.0	0.65	1.0
4 Rubber material	Millable urethane	Millable urethane	Chloroprene rubber	Chloroprene rubber	Chloroprene rubber	Nitrile rubber	Nitrile rubber
5 Surface figure	Impregnated surface	Polished surface	Smooth surface	Impregnated surface	Polished surface	Impregnated surface	Polished surface
6 Pulley surface figure	Polished surface	Glossy surface	Glossy surface	Polished surface	Glossy surface	Polished surface	Glossy surface
7 Weight	6.5	10	4.5	6	10	6.5	10
8 Breaking strength (N/mm width)	8.83	8.83	8.83	8.83	8.83	8.83	8.83
9 Standard elongation rate (%)	2.0	2.0	2.0	2.0	2.0	2.0	2.0
10 Axial load at the standard elongation rate under stable conditions (N/mm width)	1.47	1.47	1.47	1.47	1.47	1.47	1.47
11 Friction coefficient (against SUS)	Top surface	0.3 to 0.6	0.4 to 0.8	0.4 to 0.9	0.3 to 0.6	0.4 to 0.8	0.3 to 0.6
	Pulley surface	0.4 to 0.8	0.5 to 1.0	0.4 to 0.9	0.4 to 0.8	0.5 to 1.0	0.4 to 0.8
12 Minimum pulley diameter (mm)	φ6	φ10	φ5	φ6	φ10	φ8	φ15
13 Operating temperature range	-20 to +60	-20 to +60	-20 to +80	-20 to +80	-20 to +80	-20 to +80	-20 to +80

Standard Dimensional Tolerance

(1) Width (mm)		(2) Thickness (mm)	
Width	Tolerance	Thickness	Tolerance
3 or more and less than 11	±0.3	±0.43	±0.05
11 or more and less than 21	±0.5	0.6 or more and less than 0.8	±0.05
21 or more and less than 101	±1.0	0.8 or more and less than 1.0	±0.06
101 or more	±1.5	1.0 or more	±0.10

(3) G15-SB/SBU/SBC2/G30-SBC* Type: List of Inner Peripheral Lengths (mm)

Inner peripheral length of less than 300	300 or more and less than 500	500 or more and less than 700	700 or more and less than 900	900 or more and less than 1100	1100 or more						
Tolerance: ± 2 mm	Tolerance: ± 3 mm	Tolerance: ± 4 mm	Tolerance: ± 4.5 mm	Tolerance: ± 5.5 mm	Tolerance: ± 0.5 %						
97.0	138.0	186.0	247.0	300.0	373.5	455.0	504.0	601.5	702.0	906.5	1111.0
100.5	139.0	190.0	247.5	300.5	377.5	458.0	506.0	605.5	706.5	916.5	1126.0
101.0	139.5	192.0	250.0	302.0	382.0	460.5	511.0	608.5	713.0	920.5	1146.5
103.5	140.5	193.5	251.5	304.5	385.5	465.0	511.5	616.0	714.0	943.5	1152.0
104.0	142.0	195.0	252.5	306.0	389.0	468.5	520.0	621.0	726.0	958.5	1153.5
105.5	143.5	198.5	255.0	307.0	391.5	471.5	520.5	632.0	736.0	969.0	1174.5
106.5	145.0	201.0	256.5	310.0	394.5	475.5	524.0	640.5	741.5	982.0	1184.5
108.5	146.0	202.5	261.0	313.5	398.5	483.5	530.0	644.0	742.5	988.5	1202.0
109.5	149.5	205.5	264.5	319.0	403.0	494.0	535.0	650.0	749.0	1004.5	1211.5
110.5	150.5	206.0	267.5	320.5	406.5	496.0	538.0	654.5	756.5	1009.0	1217.0
112.5	151.0	209.0	271.0	322.5	411.0		543.5	656.5	761.5	1024.5	1241.5
113.5	154.0	212.0	273.0	325.5	412.5		546.5	662.5	767.5	1030.0	1262.5
114.0	156.0	213.5	275.5	326.5	413.5		549.5	667.0	770.5	1032.0	1273.5
115.0	157.5	215.0	277.5	329.0	414.5		554.0	671.0	777.0	1036.0	1282.5
116.5	160.0	218.0	278.5	329.5	416.5		558.0	675.5	791.5	1051.0	1313.0
117.5	161.5	222.0	282.5	330.0	420.5		558.5	681.5	806.5	1060.5	1321.0
118.5	163.5	223.0	284.0	332.5	422.5		560.0	690.5	822.0	1069.0	1344.5
120.0	164.5	226.0	285.0	339.5	425.0		560.5	698.5	837.5	1074.5	1359.5
123.0	167.0	229.0	286.0	346.0	426.0		565.0	706.5	856.5	1076.5	1409.0
125.0	168.0	230.5	287.5	350.5	426.5		565.5	710.0	857.0	1081.0	1429.5
127.0	171.0	236.0	288.5	351.0	427.5		573.5	715.0	864.5	1083.0	1445.0
128.5	173.5	237.0	291.0	352.5	430.5		579.5	719.0	876.0	1091.0	1461.5
129.5	176.0	238.5	292.5	358.5	432.5		585.0	724.0	884.0	1099.5	1492.5
130.0	177.5	240.5	297.5	363.0	438.5		587.5	728.0	891.0	1107.5	1508.5
132.0	180.5	241.5		368.5	444.5		591.0	732.0	895.5	1111.0	1547.5
133.5	182.0	244.5		372.0	448.5		594.5	736.0	899.5	1115.0	1562.5
135.5	185.0	246.5		372.5	453.0		597.0				

(4) G15-LB□/SBC1 Type: List of Inner Peripheral Lengths (mm)

Inner peripheral length of less than 300	300 or more and less than 500	500 or more and less than 700	700 or more and less than 900	900 or more and less than 1100	1100 or more						
Tolerance: ± 2 mm	Tolerance: ± 3 mm	Tolerance: ± 4 mm	Tolerance: ± 4.5 mm	Tolerance: ± 5.5 mm	Tolerance: ± 0.5 %						
98.5	139.5	188.0	246.0	301.5	375.0	455.0	505.5	610.0	700.0	908.0	1101.0
102.0	140.5	191.5	248.0	302.0	379.0	456.5	507.5	617.5	703.5	918.0	1112.5
102.5	141.5	193.5	248.5	303.5	384.0	459.5	513.0	622.5	708.0	922.5	1127.5
105.0	142.0	195.0	249.0	306.0	387.0	462.0	522.0	633.5	715.0	945.0	1148.0
105.5	144.0	196.5	251.5	308.5	390.5	466.5	522.5	642.0	715.5	960.0	1154.0
107.5	145.0	200.5	253.0	309.0	393.0	470.0	525.5	645.5	727.5	971.0	1155.0
108.0	146.5	202.5	254.0	311.5	396.0	473.0	532.0	656.0	737.5	984.0	1176.0
110.0	148.0	204.0	256.5	315.0	400.0	477.0	537.0	658.0	744.0	990.0	1186.0
111.5	151.0	205.0	258.5	320.5	404.5	485.0	539.5	664.0	750.5	1006.0	1203.5
112.5	152.0	206.5	263.0	322.0	408.0	495.5	545.0	668.5	758.0	1010.5	1213.0
114.0	152.5	207.5	265.5	324.0	412.5	498.0	548.0	672.5	763.0	1026.0	1218.5
114.5	155.5	210.5	269.5	327.5	414.0		551.0	677.0	769.0	1030.0	1243.0
115.0	157.5	213.5	272.5	328.0	415.0		555.5	683.0	772.0	1033.5	1264.0
116.5	159.0	214.5	274.5	330.5	416.0		560.0	692.0	778.5	1037.5	1275.0
118.0	161.5	215.5	277.0	331.0	418.0		561.0	700.0	793.0	1052.5	1284.0
119.0	163.0	216.5	279.5	332.0	422.0		561.5	708.0	808.0	1062.0	1314.5
120.0	165.0	219.5	280.0	334.0	424.0		566.5	710.5	823.5	1070.5	1322.5
121.0	166.0	223.5	284.0	341.0	425.5		567.0	718.0	839.0	1076.0	1346.0
124.5	169.0	224.5	285.5	348.0	426.5		575.5	725.0	858.5	1078.0	1361.0
126.5	170.0	227.5	287.0	352.0	427.5		581.0	728.0	866.0	1082.0	1411.0
128.5	172.5	230.5	287.5	353.0	428.0		586.5	732.0	877.5	1084.5	1431.0
130.0	175.0	232.0	289.0	354.0	429.0		589.0	736.0	885.5	1093.0	1446.5
131.0	177.5	237.5	290.0	360.0	432.0		590.5	740.0			1463.0
131.5	179.5	238.5	292.5	364.5	434.0		596.0	744.0			1494.0
133.5	182.5	240.5	294.0	370.0	440.0		598.5	748.0			1510.0
135.0	184.0	242.5	299.0	373.0	446.0		603.0	752.0			1549.0
137.0	186.5	243.0		374.0	450.0		607.0				1564.0

*If you wish to order a product with a size other than the standard, consult us.
 *SEB is built to order; the minimum order quantity is one lot. For details, contact our agencies or our sales representative.

Conveyor and Low-Load Power Transmission Belt

G30 Series

Feature: This belt, which uses thin, polyester seamless woven fabric as a tension member, is applied to conveyance and low-load power transmission.
 Use: ATM, copy machine sorters, minute-torque precision power transmission, OA equipment, etc.

Cross Section

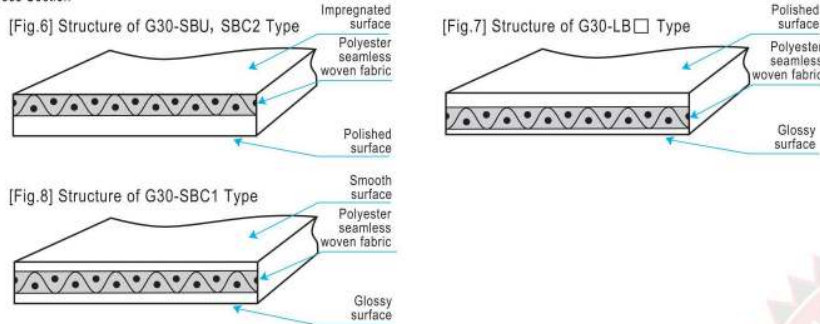

Types and Properties

Item	G30-SBU	G30-LBU	G30-SBC1	G30-SBC2	G30-LBC	G30-LB	
1 Structure	Fig. 6	Fig. 7	Fig. 8	Fig. 6	Fig. 7	Fig. 7	
2 Available width (mm)	3 to 200	3 to 200	3 to 200	3 to 200	3 to 200	3 to 200	
3 Standard thickness (mm)	0.8	1.0	0.5	0.6	1.0	1.0	
4 Rubber material	Millable urethane	Millable urethane	Chloroprene rubber	Chloroprene rubber	Chloroprene rubber	Nitrile rubber	
5 Surface figure	Impregnated surface	Polished surface	Smooth surface	Impregnated surface	Polished surface	Polished surface	
6 Pulley surface figure	Polished surface	Glossy surface	Glossy surface	Polished surface	Glossy surface	Glossy surface	
7 Weight	8	10	5	6	10	10	
8 Breaking strength (N/mm width)	17.7	17.7	17.7	17.7	17.7	17.7	
9 Standard elongation rate (%)	2.0	2.0	2.0	2.0	2.0	2.0	
10 Axial load at the standard elongation rate under stable conditions (N/mm width)	2.94	2.94	2.94	2.94	2.94	2.94	
11 Friction coefficient (against SUS)	Top surface	0.3 to 0.6	0.4 to 0.8	0.4 to 0.9	0.3 to 0.6	0.4 to 0.8	0.4 to 0.8
	Pulley surface	0.4 to 0.8	0.5 to 1.0	0.4 to 0.9	0.4 to 0.8	0.5 to 1.0	0.5 to 1.0
12 Minimum pulley diameter (mm)	φ8	φ10	φ5	φ6	φ10	φ15	
13 Operating temperature range	-20 to +60	-20 to +60	-20 to +80	-20 to +80	-20 to +80	-20 to +80	

Standard Dimensional Tolerance

(1) Width (mm)		(2) Thickness (mm) <small>*For G30-SBC1 only</small>	
Width	Tolerance	Thickness	Tolerance
3 or more and less than 11	±0.3	※0.50	±0.05
11 or more and less than 21	±0.5	0.6 or more and less than 0.8	±0.05
21 or more and less than 101	±1.0	0.8 or more and less than 1.0	±0.06
101 or more	±1.5	1.0 or more	±0.10

(3) G30-SBU (Thickness: 0.8 mm) Type: List of Inner Peripheral Lengths (mm)

Less than 300		300 or more and less than 500		500 or more and less than 700		700 or more and less than 900		900 or more and less than 1100		1100 or more	
Tolerance: ± 2 mm		Tolerance: ± 3 mm		Tolerance: ± 4 mm		Tolerance: ± 4.5 mm		Tolerance: ± 5.5 mm		Tolerance: ± 0.5 %	
96.5	137.5	190.5	247.0	301.0	385.0	460.0	502.5	631.5	701.0	905.0	1108.0
99.0	138.0	192.5	249.0	303.5	388.0	463.5	504.5	639.5	706.0	914.5	1123.5
100.0	139.5	194.0	250.0	305.5	389.5	467.5	510.5	643.0	712.5	920.0	1144.0
102.0	141.5	198.0	251.5	307.0	393.5	470.5	518.5	654.0	713.0	942.5	1150.0
102.5	142.0	200.0	254.5	309.0	397.5	475.0	522.5	655.0	725.0	958.0	1150.5
104.5	143.5	201.5	256.0	313.0	402.0	482.5	529.0	660.5	735.0	967.5	1171.5
106.0	145.5	205.0	259.5	318.0	405.5	493.0	533.0	666.0	742.0	980.5	1181.5
107.5	149.0	206.0	260.0	319.0	410.0	495.0	537.5	670.0	748.0	987.5	1199.5
108.5	150.0	208.0	263.5	321.5	411.0		543.0	674.5	755.5	1004.0	1208.5
110.0	150.5	211.5	266.5	325.5	412.5		545.5	681.0	760.5	1008.0	1214.5
111.5	153.5	213.0	270.0	326.0	413.5		548.5	690.0	765.5	1022.5	1239.5
112.5	154.0	213.5	272.0	328.0	414.0		552.5	698.0	770.5	1029.0	1261.0
113.0	157.0	217.0	274.0	329.0	415.5		558.0		776.0	1031.0	1271.0
114.0	158.5	221.0	276.5	332.0	419.0		560.0		790.5	1033.5	1280.5
115.0	160.5	222.0	278.0	339.0	422.0		563.5		805.5	1048.5	1310.5
117.0	162.5	225.0	281.0	345.5	424.5		573.5		821.0	1058.0	1318.5
118.0	163.5	228.0	283.0	349.5	425.0		578.5		836.0	1068.0	1343.0
119.5	166.5	229.5	284.5	350.0	426.0		584.0		856.0	1074.0	1358.5
122.5	167.5	234.5	285.0	351.5	427.0		587.0		863.0	1075.0	1407.0
124.5	170.5	236.0	286.0	358.0	430.0		590.0		874.5	1079.0	1427.5
126.0	172.0	238.0	288.0	361.5	431.5		593.5		883.5	1081.5	1442.5
127.5	175.5	240.0	290.0	368.0	438.0		596.0			1088.5	1459.0
128.5	177.0	240.5	292.0	372.0	443.0		600.5			1097.0	1489.5
129.0	180.0	244.0	297.0	372.5	447.5		604.5				1505.5
130.5	181.0	245.5	299.0	374.0	451.0		607.5				1545.0
132.5	184.0	246.0	299.5	377.0	454.5		615.0				1560.0
134.5	189.0	246.5		381.5	457.0		620.0				

(4) G30-LB □/SBC1 Type: List of Inner Peripheral Lengths (mm)

Less than 300		300 or more and less than 500		500 or more and less than 700		700 or more and less than 900		900 or more and less than 1100		1100 or more	
Tolerance: ± 2 mm		Tolerance: ± 3 mm		Tolerance: ± 4 mm		Tolerance: ± 4.5 mm		Tolerance: ± 5.5 mm		Tolerance: ± 0.5 %	
98.5	139.5	188.0	246.0	301.5	375.0	455.0	505.5	610.0	700.0	908.0	1101.0
102.0	140.5	191.5	248.0	302.0	379.0	456.5	507.5	617.5	703.5	918.0	1112.5
102.5	141.5	193.5	248.5	303.5	384.0	459.5	513.0	622.5	708.0	922.5	1127.5
105.0	142.0	195.0	249.0	306.0	387.0	462.0	522.0	633.5	715.0	945.0	1148.0
105.5	144.0	196.5	251.5	308.5	390.5	466.5	522.5	642.0	715.5	960.0	1154.0
107.5	145.0	200.5	253.0	309.0	393.0	470.0	525.5	645.5	727.5	971.0	1155.0
108.0	146.5	202.5	254.0	311.5	396.0	473.0	532.0	656.0	737.5	984.0	1176.0
110.0	149.0	204.0	256.5	315.0	400.0	477.0	537.0	658.0	744.0	990.0	1186.0
111.5	151.0	205.0	258.5	320.5	404.5	485.0	539.5	664.0	750.5	1006.0	1203.5
112.5	152.0	206.5	263.0	322.0	408.0	495.5	545.0	668.5	758.0	1010.5	1213.0
114.0	152.5	207.5	265.5	324.0	412.5	498.0	548.0	672.5	763.0	1026.0	1218.5
114.5	155.5	210.5	269.5	327.5	414.0		551.0	677.0	769.0	1030.0	1243.0
115.0	157.5	213.5	272.5	328.0	415.0		555.5	683.0	772.0	1033.5	1264.0
116.5	159.0	214.5	274.5	330.5	416.0		560.0	692.0	778.5	1037.5	1275.0
118.0	161.5	215.5	277.0	331.0	418.0		561.0		793.0	1052.5	1284.0
119.0	163.0	216.5	279.5	332.0	422.0		561.5		808.0	1062.0	1314.5
120.0	165.0	219.5	280.0	334.0	424.0		566.5		823.5	1070.5	1322.5
121.0	166.0	223.5	284.0	341.0	425.5		567.0		839.0	1076.0	1346.0
124.5	169.0	224.5	285.5	348.0	426.5		575.5		858.5	1078.0	1361.0
126.5	170.0	227.5	287.0	352.0	427.5		581.0		866.0	1082.0	1411.0
128.5	172.5	230.5	287.5	353.0	428.0		586.5		877.5	1084.5	1431.0
130.0	175.0	232.0	289.0	354.0	429.0		589.0		885.5	1093.0	1446.5
131.0	177.5	237.5	290.0	360.0	432.0		592.5				1463.0
131.5	179.5	238.5	292.5	364.5	434.0		596.0				1494.0
133.5	182.5	240.5	294.0	370.0	440.0		598.5				1510.0
135.0	184.0	242.5	299.0	373.0	446.0		603.0				1549.0
137.0	186.5	243.0		374.0	450.0		607.0				1564.0

* If you wish to order a product with a size other than the standard, consult us.
 * SEB is built to order; the minimum order quantity is one lot.

Conveyor and Medium-Load Power Transmission Belt

F50 Series

Feature: This belt, which uses polyester seamless woven fabric as a tension member, is applied to conveyance and power transmission.
 Use: OA equipment, ticket-vending machines, ATM, etc.
 Cross Section

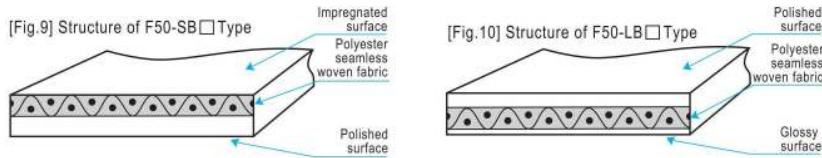

Types and Properties

Item	F50-SBU	F50-LBU	F50-SBC2	F50-LBC	F50-SB	F50-LB	
1 Structure	Fig. 9	Fig. 10	Fig. 9	Fig. 10	Fig. 9	Fig. 10	
2 Available width (mm)	5 to 200	5 to 200	5 to 200	5 to 200	5 to 200	5 to 200	
3 Standard thickness (mm)	0.8	1.0	0.8	1.0	0.8	1.0	
4 Rubber material	Millable urethane	Millable urethane	Chloroprene rubber	Chloroprene rubber	Nitrile rubber	Nitrile rubber	
5 Surface figure	Impregnated surface	Polished surface	Impregnated surface	Polished surface	Impregnated surface	Polished surface	
6 Pulley surface figure	Polished surface	Glossy surface	Polished surface	Glossy surface	Polished surface	Glossy surface	
7 Weight	8	10	8	10	8	10	
8 Breaking strength (N/mm width)	24.5	24.5	24.5	24.5	24.5	24.5	
9 Standard elongation rate (%)	2.0	2.0	2.0	2.0	2.0	2.0	
10 Axial load at the standard elongation rate under stable conditions (N/mm width)	4.9	4.9	4.9	4.9	4.9	4.9	
11 Friction coefficient (against SUS)	Top surface	0.3 to 0.6	0.4 to 0.8	0.3 to 0.6	0.4 to 0.8	0.3 to 0.6	0.4 to 0.8
	Pulley surface	0.4 to 0.8	0.5 to 1.0	0.4 to 0.8	0.5 to 1.0	0.4 to 0.8	0.5 to 1.0
12 Minimum pulley diameter (mm)	φ10	φ15	φ10	φ15	φ15	φ20	
13 Operating temperature range	-20 to +60	-20 to +60	-20 to +80	-20 to +80	-20 to +80	-20 to +80	

Standard Dimensional Tolerance

(1) Width (mm)

Width	Tolerance
5 or more and less than 11	±0.3
11 or more and less than 21	±0.5
21 or more and less than 101	±1.0
101 or more	±1.5

(2) Thickness (mm)

Thickness	Tolerance
0.8 or more and less than 1.0	±0.06
1.0 or more	±0.10

(3) F50-SB□ (Thickness: 0.8 mm) Type: List of Inner Peripheral Lengths (mm)

Inner peripheral length of less than 300	300 or more and less than 500	500 or more and less than 700	700 or more and less than 900	900 or more and less than 1100	1100 or more						
Tolerance: ± 2 mm	Tolerance: ± 3 mm	Tolerance: ± 4 mm	Tolerance: ± 4.5 mm	Tolerance: ± 5.5 mm	Tolerance: ± 0.5 %						
96.5	137.5	190.5	247.0	301.0	385.0	460.0	502.5	631.5	701.0	905.0	1108.0
99.0	138.0	192.5	249.0	303.5	388.0	463.5	504.5	639.5	706.0	914.5	1123.5
100.0	139.5	194.0	250.0	305.5	389.5	467.5	510.5	643.0	712.5	920.0	1144.0
102.0	141.5	198.0	251.5	307.0	393.5	470.5	518.5	654.0	713.0	942.5	1150.0
102.5	142.0	200.0	254.5	309.0	397.5	475.0	522.5	655.0	725.0	958.0	1150.5
104.5	143.5	201.5	256.0	313.0	402.0	482.5	529.0	660.5	735.0	967.5	1171.5
106.0	145.5	205.0	259.5	318.0	405.5	493.0	533.0	666.0	742.0	980.5	1181.5
107.5	149.0	206.0	260.0	319.0	410.0	495.0	537.5	670.0	748.0	987.5	1199.5
108.5	150.0	208.0	263.5	321.5	411.0		543.0	674.5	755.5	1004.0	1208.5
110.0	150.5	211.5	266.5	325.5	412.5		545.5	681.0	760.5	1008.0	1214.5
111.5	153.5	213.0	270.0	326.0	413.5		548.5	690.0	765.5	1022.5	1239.5
112.5	154.0	213.5	272.0	328.0	414.0		552.5	698.0	770.5	1029.0	1261.0
113.0	157.0	217.0	274.0	329.0	415.5		558.0		776.0	1031.0	1271.0
114.0	158.5	221.0	276.5	332.0	419.0		560.0		790.5	1033.5	1280.5
115.0	160.5	222.0	278.0	339.0	422.0		563.5		805.5	1048.5	1310.5
117.0	162.5	225.0	281.0	345.5	424.5		573.5		821.0	1058.0	1318.5
118.0	163.5	228.0	283.0	349.5	425.0		578.5		836.0	1068.0	1343.0
119.5	166.5	229.5	284.5	350.0	426.0		584.0		856.0	1074.0	1358.5
122.5	167.5	234.5	285.0	351.5	427.0		587.0		863.0	1075.0	1407.0
124.5	170.5	236.0	286.0	358.0	430.0		590.0		874.5	1079.0	1427.5
126.0	172.0	238.0	288.0	361.5	431.5		593.5		883.5	1081.5	1442.5
127.5	175.5	240.0	290.0	368.0	438.0		596.0			1088.5	1459.0
128.5	177.0	240.5	292.0	372.0	443.0		600.5			1097.0	1489.5
129.0	180.0	244.0	297.0	372.5	447.5		604.5				1505.5
130.5	181.0	245.5	299.0	374.0	451.0		607.5				1545.0
132.5	184.0	246.0	299.5	377.0	454.5		615.0				1560.0
134.5	189.0	246.5		381.5	457.0		620.0				

(4) F50-LB□ (Thickness: 1.0 mm) Type: List of Inner Peripheral Lengths (mm)

Inner peripheral length of less than 300	300 or more and less than 500	500 or more and less than 700	700 or more and less than 900	900 or more and less than 1100	1100 or more						
Tolerance: ± 2 mm	Tolerance: ± 3 mm	Tolerance: ± 4 mm	Tolerance: ± 4.5 mm	Tolerance: ± 5.5 mm	Tolerance: ± 0.5 %						
98.5	139.5	188.0	246.0	301.5	375.0	455.0	505.5	610.0	700.0	908.0	1101.0
102.0	140.5	191.5	248.0	302.0	379.0	456.5	507.5	617.5	703.5	918.0	1112.5
102.5	141.5	193.5	248.5	303.5	384.0	459.5	513.0	622.5	708.0	922.5	1127.5
105.0	142.0	195.0	249.0	306.0	387.0	462.0	522.0	633.5	715.0	945.0	1148.0
105.5	144.0	196.5	251.5	308.5	390.5	466.5	522.5	642.0	715.5	960.0	1154.0
107.5	145.0	200.5	253.0	309.0	393.0	470.0	525.5	645.5	727.5	971.0	1155.0
108.0	146.5	202.5	254.0	311.5	396.0	473.0	532.0	656.0	737.5	984.0	1176.0
110.0	148.0	204.0	256.5	315.0	400.0	477.0	537.0	658.0	744.0	990.0	1186.0
111.5	151.0	205.0	258.5	320.5	404.5	485.0	539.5	664.0	750.5	1006.0	1203.5
112.5	152.0	206.5	263.0	322.0	408.0	495.5	545.0	668.5	758.0	1010.5	1213.0
114.0	152.5	207.5	265.5	324.0	412.5	498.0	548.0	672.5	763.0	1026.0	1218.5
114.5	155.5	210.5	269.5	327.5	414.0		551.0	677.0	769.0	1030.0	1243.0
115.0	157.5	213.5	272.5	328.0	415.0		555.5	683.0	772.0	1033.5	1264.0
116.5	159.0	214.5	274.5	330.5	416.0		560.0	692.0	778.5	1037.5	1275.0
118.0	161.5	215.5	277.0	331.0	418.0		561.0		793.0	1052.5	1284.0
119.0	163.0	216.5	279.5	332.0	422.0		561.5		808.0	1062.0	1314.5
120.0	165.0	219.5	280.0	334.0	424.0		566.5		823.5	1070.5	1322.5
121.0	166.0	223.5	284.0	341.0	425.5		567.0		839.0	1076.0	1346.0
124.5	169.0	224.5	285.5	348.0	426.5		575.5		858.5	1076.0	1361.0
126.5	170.0	227.5	287.0	352.0	427.5		581.0		866.0	1082.0	1411.0
128.5	172.5	230.5	287.5	353.0	428.0		586.5		877.5	1084.5	1431.0
130.0	175.0	232.0	289.0	354.0	429.0		589.0		885.5	1093.0	1446.5
131.0	177.5	237.5	290.0	360.0	432.0		592.5				1463.0
131.5	179.5	238.5	292.5	364.5	434.0		596.0				1494.0
133.5	182.5	240.5	294.0	370.0	440.0		598.5				1510.0
135.0	184.0	242.5	299.0	373.0	446.0		603.0				1549.0
137.0	186.5	243.0		374.0	450.0		607.0				1564.0

*If you wish to order a product with a size other than the standard, consult us.
 *SEB is built to order; the minimum order quantity is one lot. For details, contact our agencies or our sales representative.

Conveyor and Medium-Load Power Transmission Belt

F100 Series

Feature: This belt, which uses polyester seamless woven fabric as a tension member, is applied to conveyance and power transmission.
Use: OA equipment, ticket-vending machines, ATM, etc.

Cross Section

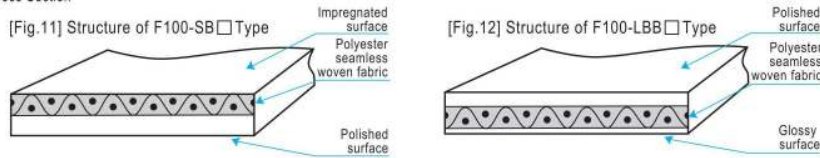

Types and Properties

Item	F100-SBU	F100-LBU	F100-SBC2	F100-LBC	F100-SB	F100-LB	
1 Structure	Fig. 11	Fig. 12	Fig. 11	Fig. 12	Fig. 11	Fig. 12	
2 Available width (mm)	5 to 200	5 to 200	5 to 200	5 to 200	5 to 200	5 to 200	
3 Standard thickness (mm)	0.8	1.0	0.8	1.0	0.8	1.0	
4 Rubber material	Millable urethane	Millable urethane	Chloroprene rubber	Chloroprene rubber	Nitrile rubber	Nitrile rubber	
5 Surface figure	Impregnated surface	Polished surface	Impregnated surface	Polished surface	Impregnated surface	Polished surface	
6 Pulley surface figure	Polished surface	Glossy surface	Polished surface	Glossy surface	Polished surface	Glossy surface	
7 Weight	8	10	8	10	8	10	
8 Breaking strength (N/mm width)	39.2	39.2	39.2	39.2	39.2	39.2	
9 Standard elongation rate (%)	2.0	2.0	2.0	2.0	2.0	2.0	
10 Axial load at the standard elongation rate under stable conditions (N/mm width)	7.84	7.84	7.84	7.84	7.84	7.84	
11 Friction coefficient (against SUS)	Top surface	0.3 to 0.6	0.4 to 0.8	0.3 to 0.6	0.4 to 0.8	0.3 to 0.6	0.4 to 0.8
	Pulley surface	0.4 to 0.8	0.5 to 1.0	0.4 to 0.8	0.5 to 1.0	0.4 to 0.8	0.5 to 1.0
12 Minimum pulley diameter (mm)	φ10	φ15	φ10	φ15	φ15	φ20	
13 Operating temperature range	-20 to +60	-20 to +60	-20 to +80	-20 to +80	-20 to +80	-20 to +80	

Standard Dimensional Tolerance

(1) Width (mm)

Width	Tolerance
5 or more and less than 11	±0.3
11 or more and less than 21	±0.5
21 or more and less than 101	±1.0
101 or more	±1.5

(2) Thickness (mm)

Thickness	Tolerance
0.8 or more and less than 1.0	±0.06
1.0 or more	±0.10

(3) F100-SB□ (Thickness: 0.8 mm) Type: List of Inner Peripheral Lengths (mm)

Inner peripheral length of less than 300		300 or more and less than 500		500 or more and less than 700		700 or more and less than 900		900 or more and less than 1100		1100 or more	
Tolerance: ± 2 mm		Tolerance: ± 3 mm		Tolerance: ± 4 mm		Tolerance: ± 4.5 mm		Tolerance: ± 5.5 mm		Tolerance: ± 0.5 %	
96.5	137.5	190.5	247.0	301.0	385.0	460.0	502.5	631.5	701.0	905.0	1108.0
99.0	138.0	192.5	249.0	303.5	388.0	463.5	504.5	639.5	706.0	914.5	1123.5
100.0	139.5	194.0	250.0	305.5	389.5	467.5	510.5	643.0	712.5	920.0	1144.0
102.0	141.5	198.0	251.5	307.0	393.5	470.5	518.5	654.0	713.0	942.5	1150.0
102.5	142.0	200.0	254.5	309.0	397.5	475.0	522.5	655.0	725.0	958.0	1150.5
104.5	143.5	201.5	256.0	313.0	402.0	482.5	529.0	660.5	735.0	967.5	1171.5
106.0	145.5	205.0	259.5	318.0	405.5	493.0	533.0	666.0	742.0	980.5	1181.5
107.5	149.0	206.0	260.0	319.0	410.0	495.0	537.5	670.0	748.0	987.5	1199.5
108.5	150.0	208.0	263.5	321.5	411.0		543.0	674.5	755.5	1004.0	1208.5
110.0	150.5	211.5	266.5	325.5	412.5		545.5	681.0	760.5	1008.0	1214.5
111.5	153.5	213.0	270.0	326.0	413.5		548.5	690.0	765.5	1022.5	1239.5
112.5	154.0	213.5	272.0	328.0	414.0		552.5	698.0	770.5	1029.0	1261.0
113.0	157.0	217.0	274.0	329.0	415.5		558.0		776.0	1031.0	1271.0
114.0	158.5	221.0	276.5	332.0	419.0		560.0		790.5	1033.5	1280.5
115.0	160.5	222.0	278.0	339.0	422.0		563.5		805.5	1048.5	1310.5
117.0	162.5	225.0	281.0	345.5	424.5		573.5		821.0	1058.0	1318.5
118.0	163.5	228.0	283.0	349.5	425.0		578.5		836.0	1068.0	1343.0
119.5	166.5	229.5	284.5	350.0	426.0		584.0		856.0	1074.0	1358.5
122.5	167.5	234.5	285.0	351.5	427.0		587.0		863.0	1075.0	1407.0
124.5	170.5	236.0	286.0	358.0	430.0		590.0		874.5	1079.0	1427.5
126.0	172.0	238.0	288.0	361.5	431.5		593.5		883.5	1091.5	1442.5
127.5	175.5	240.0	290.0	368.0	438.0		596.0			1088.5	1459.0
128.5	177.0	240.5	292.0	372.0	443.0		600.5			1097.0	1489.5
129.0	180.0	244.0	297.0	372.5	447.5		604.5				1505.5
130.5	181.0	245.5	299.0	374.0	451.0		607.5				1545.0
132.5	184.0	248.0	299.5	377.0	454.5		615.0				1560.0
134.5	189.0	246.5		381.5	457.0		620.0				

(4) F100-LB□ (Thickness: 1.0 mm) Type: List of Inner Peripheral Lengths (mm)

Inner peripheral length of less than 300		300 or more and less than 500		500 or more and less than 700		700 or more and less than 900		900 or more and less than 1100		1100 or more	
Tolerance: ± 2 mm		Tolerance: ± 3 mm		Tolerance: ± 4 mm		Tolerance: ± 4.5 mm		Tolerance: ± 5.5 mm		Tolerance: ± 0.5 %	
98.5	139.5	188.0	246.0	301.5	375.0	455.0	505.5	610.0	700.0	908.0	1101.0
102.0	140.5	191.5	248.0	302.0	379.0	456.5	507.5	617.5	703.5	918.0	1112.5
102.5	141.5	193.5	248.5	303.5	384.0	459.5	513.0	622.5	708.0	922.5	1127.5
105.0	142.0	195.0	249.0	306.0	387.0	462.0	522.0	633.5	715.0	945.0	1148.0
105.5	144.0	196.5	251.5	308.5	390.5	466.5	522.5	642.0	715.5	960.0	1154.0
107.5	145.0	200.5	253.0	309.0	393.0	470.0	525.5	645.5	727.5	971.0	1155.0
108.0	146.5	202.5	254.0	311.5	396.0	473.0	532.0	656.0	737.5	984.0	1176.0
110.0	148.0	204.0	256.5	315.0	400.0	477.0	537.0	658.0	744.0	990.0	1186.0
111.5	151.0	205.0	256.5	320.5	404.5	485.0	539.5	664.0	750.5	1008.0	1203.5
112.5	152.0	206.5	263.0	322.0	408.0	495.5	545.0	668.5	758.0	1010.5	1213.0
114.0	152.5	207.5	265.5	324.0	412.5	498.0	548.0	672.5	763.0	1028.0	1218.5
114.5	155.5	210.5	269.5	327.5	414.0		551.0	677.0	769.0	1030.0	1243.0
115.0	157.5	213.5	272.5	328.0	415.0		555.5	683.0	772.0	1033.5	1264.0
116.5	159.0	214.5	274.5	330.5	416.0		560.0	692.0	778.5	1037.5	1275.0
118.0	161.5	215.5	277.0	331.0	418.0		561.0		793.0	1052.5	1284.0
119.0	163.0	216.5	279.5	332.0	422.0		561.5		808.0	1062.0	1314.5
120.0	165.0	219.5	280.0	334.0	424.0		566.5		823.5	1070.5	1322.5
121.0	166.0	223.5	284.0	341.0	425.5		567.0		839.0	1076.0	1346.0
124.5	169.0	224.5	285.5	348.0	426.5		575.5		858.5	1078.0	1361.0
126.5	170.0	227.5	287.0	352.0	427.5		581.0		866.0	1082.0	1411.0
128.5	172.5	230.5	287.5	353.0	428.0		586.5		877.5	1084.5	1431.0
130.0	175.0	232.0	289.0	354.0	429.0		589.0		885.5	1093.0	1446.5
131.0	177.5	237.5	290.0	360.0	432.0		592.5				1463.0
131.5	179.5	238.5	292.5	364.5	434.0		596.0				1494.0
133.5	182.5	240.5	294.0	370.0	440.0		598.5				1510.0
135.0	184.0	242.5	299.0	373.0	446.0		603.0				1549.0
137.0	186.5	243.0		374.0	450.0		607.0				1564.0

*If you wish to order a product with a size other than the standard, consult us.
*SEB is built to order; the minimum order quantity is one lot. For details, contact our agencies or our sales representative.

Medium-Load Power Transmission Belt

XA·A Series

Feature: This belt, which uses a cord as a tension member, is applied to medium-load power transmission.

Use: Low-torque, high-speed power transmission, draw texturing machines, feeder belts, etc.

Cross Section

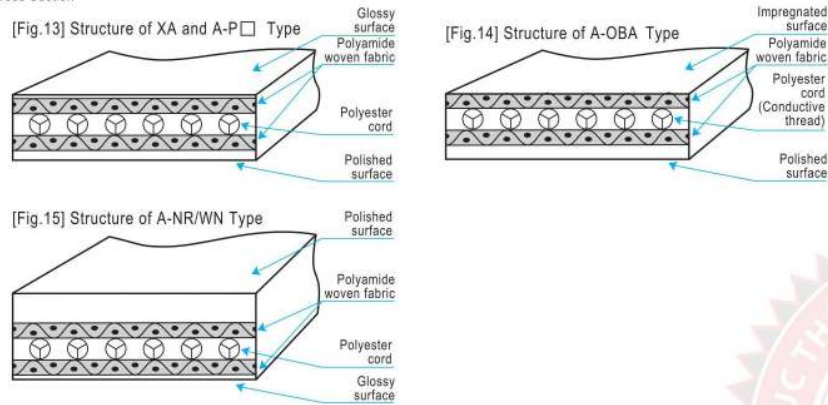

Types and Properties

Item	XA-PB	A-PB	A-OBA	A-PC	A-NR	A-WN
1 Structure	Fig. 13	Fig. 13	Fig. 14	Fig. 13	Fig. 15	Fig. 15
2 Available width (mm) ^{※1}	5 to 400	5 to 400	5 to 400	5 to 400	7 to 400	7 to 400
3 Standard thickness (mm) ^{※2}	1.1	1.2	1.2	1.2	3.0 to 8.0	3.0 to 8.0
4 Rubber material	Nitrile rubber	Nitrile rubber	Nitrile rubber	Chloroprene rubber	Blue natural rubber	White natural rubber
5 Surface figure	Glossy surface	Glossy surface	Impregnated surface	Glossy surface	Polished surface	Polished surface
6 Pulley surface figure	Polished surface	Polished surface	Polished surface	Polished surface	Glossy surface	Glossy surface
7 Weight	12	14	14	14	102	102
8 Breaking strength (N/mm width)	29.4	58.8	58.8	58.8	58.8	58.8
9 Standard elongation rate (%)	1.0	1.0	1.0	1.0	0.5	0.5
10 Axial load at the standard elongation rate under stable conditions (N/mm width)	7.35	14.7	14.7	14.7	7.35	7.35
11 Friction coefficient (against SUS)	Top surface	0.2 to 0.4	0.2 to 0.4	0.1 to 0.3	0.2 to 0.4	2.0 (Against cardboard)
	Pulley surface	0.4 to 0.8	0.4 to 0.8	0.4 to 0.8	0.4 to 0.8	1.5 (Against cardboard)
12 Minimum pulley diameter (mm)	φ15	φ15	φ15	φ15	φ80	φ80
13 Operating temperature range	-20 to +80	-20 to +80	-20 to +80	-20 to +80	-20 to +60	-20 to +60

※1 The maximum width of the above types (except for A-NR and A-WN) is 1/5 of the inner peripheral length.
 ※2 For A-NR and A-WN, specify thickness. (We provide you a belt with a length on a 1 mm basis)

Standard Dimensional Tolerance

(1) Width (mm)

Width	Tolerance
5 or more and less than 11	±0.3
11 or more and less than 21	±0.5
21 or more and less than 101	±1.0
101 or more	±1.5

(2) Thickness (mm)

Thickness	Tolerance
1.0 or more	±0.10

Belt type	Tolerance
A-WN A-NR	±0.50

(3) XA/A Type: List of Inner Peripheral Lengths (mm)

Inner peripheral length of less than 300			300 or more and less than 600			600 or more and less than 800	800 or more and less than 1000	1000 or more		
Tolerance: ± 2 mm			Tolerance: ± 3 mm			Tolerance: ± 4 mm	Tolerance: ± 5 mm	Tolerance: ± 0.5 %		
128.0	181.0	250.0	300.0	396.0	500.0	600.0	800.0	1000.0	1300.0	2160.0
128.5	184.0	251.0	302.0	400.0	501.0	605.0	815.0	1008.0	1308.0	2181.0
129.0	189.0	254.0	305.0	404.0	508.0	610.0	830.0	1016.0	1338.0	2185.0
131.0	191.0	255.0	306.0	407.0	516.0	617.0	850.0	1021.0	1350.0	2190.0
133.0	192.0	260.0	307.0	409.0	520.0	626.0	857.0	1023.0	1396.0	2200.0
135.0	194.0	263.0	312.0	410.0	525.0	635.0	870.0	1026.0	1415.0	2230.0
137.0	198.0	266.0	316.0	411.0	529.0	638.0	876.0	1041.0	1430.0	2248.0
138.0	200.0	269.0	317.0	414.0	534.0	648.0	900.0	1050.0	1450.0	2270.0
140.0	202.0	272.0	320.0	417.0	539.0	650.0	908.0	1060.0	1478.0	2300.0
141.0	204.0	274.0	324.0	420.0	542.0	656.0	913.0	1066.0	1500.0	2360.0
143.0	205.0	276.0	326.0	421.0	545.0	660.0	935.0	1067.0	1535.0	2500.0
144.0	208.0	278.0	327.0	422.0	550.0	665.0	950.0	1071.0	1550.0	2570.0
145.0	210.0	281.0	328.0	423.0	553.0	670.0	960.0	1073.0	1590.0	2750.0
149.0	212.0	282.0	331.0	426.0	555.0	676.0	973.0	1080.0	1600.0	2808.0
149.5	214.0	283.0	338.0	427.0	560.0	685.0	980.0	1093.0	1620.0	2819.0
150.0	216.0	284.0	344.0	430.0	570.0	692.0	995.0	1100.0	1645.0	2890.0
153.0	220.0	285.0	347.0	435.0	575.0	695.0		1115.0	1653.0	3336.0
154.0	221.0	287.0	348.0	441.0	580.0	700.0		1135.0	1680.0	4525.0
157.0	224.0	289.0	350.0	445.0	583.0	707.0		1142.0	1700.0	
159.0	227.0	291.0	356.0	450.0	586.0	708.0		1145.0	1708.0	
160.0	230.0	295.0	360.0	452.0	589.0	720.0		1165.0	1800.0	
162.0	235.0	296.0	366.0	456.0	592.0	729.0		1175.0	1835.0	
164.0	236.0	298.0	369.0	457.0	597.0	736.0		1190.0	1850.0	
166.0	238.0		370.0	461.0		743.0		1200.0	1890.0	
167.0	239.0		374.0	465.0		750.0		1207.0	1965.0	
170.0	240.0		380.0	468.0		755.0		1230.0	1970.0	
172.0	243.0		382.0	472.0		760.0		1234.0	2070.0	
175.0	245.0		386.0	480.0		764.0		1250.0	2100.0	
177.0	247.0		388.0	489.0		770.0		1261.0	2118.0	
180.0	248.0		392.0	493.0		785.0		1270.0	2150.0	

* If you wish to order a product with a size other than the standard, consult us.

* SEB is built to order; the minimum order quantity is one lot. When ordering the belt with length other than the above, consult us.

For details, contact our agencies or our sales representative.

* We can provide you A-NR/A-WN with a length from 400 - 1970 mm.

High-Load Power Transmission Belt

B·D·GS Series

Feature: This belt, which uses a cord as a tension member, is mainly applied to high-load power transmission.

Use: Grinding machines, internal grinders, industrial vacuum cleaners, etc.

Cross Section

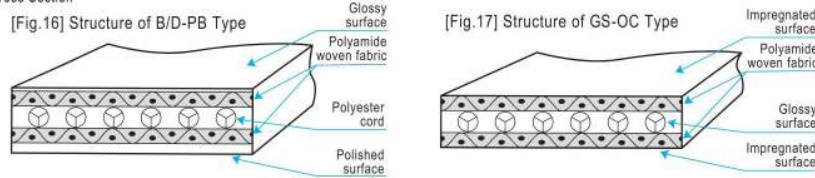

Types and Properties

Item	B - PB	D - PB	GS - OC	
1 Structure	Fig. 16	Fig. 16	Fig. 17	
2 Available width (mm) *	5 to 400	5 to 400	5 to 400	
3 Standard thickness (mm)	1.4	1.7	0.75	
4 Rubber material	Nitrile rubber	Nitrile rubber	Chloroprene rubber	
5 Surface figure	Glossy surface	Glossy surface	Impregnated surface	
6 Pulley surface figure	Polished surface	Polished surface	Impregnated surface	
7 Weight	16	20	10	
8 Breaking strength (N/mm width)	118	235	167	
9 Standard elongation rate (%)	1.0	1.0	0.3	
10 Axial load at the standard elongation rate under stable conditions (N/mm width)	29.4	58.8	14.7	
11 Friction coefficient (against SUS)	Top surface	0.2 to 0.4	0.2 to 0.4	0.1 to 0.3
	Pulley surface	0.4 to 0.8	0.4 to 0.8	0.1 to 0.3
12 Minimum pulley diameter (mm)	φ25	φ35	φ20	
13 Operating temperature range	-20 to +80	-20 to +80	-20 to +80	

*The maximum width is 1/5 of the inner peripheral length.

Standard Dimensional Tolerance

(1) Width (mm)

Width	Tolerance
5 or more and less than 11	±0.3
11 or more and less than 21	±0.5
21 or more and less than 101	±1.0
101 or more	±1.5

(2) Thickness of B/D Type (mm)

Thickness	Tolerance
0.8 or more and less than 1.0	±0.06
1.0 or more	±0.10

Belt type	Tolerance
GS-OC	±0.10
GL-OC	±0.15

(3) B/D Type: List of Inner Peripheral Lengths (mm)

Inner peripheral length of less than 300		300 or more and less than 600		600 or more and less than 800	800 or more and less than 1000	1000 or more				
Tolerance: ± 2 mm		Tolerance: ± 3 mm		Tolerance: ± 4 mm	Tolerance: ± 5 mm	Tolerance: ± 0.5 %				
128.0	181.0	250.0	300.0	396.0	500.0	600.0	800.0	1000.0	1300.0	2160.0
128.5	184.0	251.0	302.0	400.0	501.0	605.0	815.0	1008.0	1308.0	2181.0
129.0	189.0	254.0	305.0	404.0	508.0	610.0	830.0	1016.0	1338.0	2185.0
131.0	191.0	255.0	306.0	407.0	516.0	617.0	850.0	1021.0	1350.0	2190.0
133.0	192.0	260.0	307.0	409.0	520.0	626.0	857.0	1023.0	1396.0	2200.0
135.0	194.0	263.0	312.0	410.0	525.0	635.0	870.0	1026.0	1415.0	2230.0
137.0	198.0	266.0	316.0	411.0	529.0	638.0	876.0	1041.0	1430.0	2248.0
138.0	200.0	269.0	317.0	414.0	534.0	648.0	900.0	1050.0	1450.0	2270.0
140.0	202.0	272.0	320.0	417.0	539.0	650.0	908.0	1060.0	1478.0	2300.0
141.0	204.0	274.0	324.0	420.0	542.0	656.0	913.0	1066.0	1500.0	2360.0
143.0	205.0	276.0	326.0	421.0	545.0	660.0	935.0	1067.0	1535.0	2500.0
144.0	208.0	278.0	327.0	422.0	550.0	665.0	950.0	1071.0	1550.0	2570.0
145.0	210.0	281.0	328.0	423.0	553.0	670.0	960.0	1073.0	1590.0	2750.0
149.0	212.0	282.0	331.0	426.0	555.0	676.0	973.0	1080.0	1600.0	2808.0
149.5	214.0	283.0	338.0	427.0	560.0	685.0	980.0	1093.0	1620.0	2819.0
150.0	216.0	284.0	344.0	430.0	570.0	692.0	995.0	1100.0	1645.0	2890.0
153.0	220.0	285.0	347.0	435.0	575.0	695.0	1115.0	1115.0	1653.0	3336.0
154.0	221.0	287.0	348.0	441.0	580.0	700.0	1135.0	1135.0	1660.0	4525.0
157.0	224.0	289.0	350.0	445.0	583.0	707.0	1142.0	1142.0	1700.0	
159.0	227.0	291.0	356.0	450.0	586.0	708.0	1145.0	1145.0	1708.0	
160.0	230.0	295.0	360.0	452.0	589.0	720.0	1165.0	1165.0	1800.0	
162.0	235.0	296.0	366.0	456.0	592.0	729.0	1175.0	1175.0	1835.0	
164.0	236.0	298.0	369.0	457.0	597.0	736.0	1190.0	1190.0	1850.0	
166.0	238.0		370.0	461.0		743.0	1200.0	1200.0	1890.0	
167.0	239.0		374.0	465.0		750.0	1207.0	1207.0	1965.0	
170.0	240.0		380.0	468.0		755.0	1230.0	1230.0	1970.0	
172.0	243.0		382.0	472.0		760.0	1234.0	1234.0	2070.0	
175.0	245.0		386.0	480.0		764.0	1250.0	1250.0	2100.0	
177.0	247.0		388.0	489.0		770.0	1261.0	1261.0	2118.0	
180.0	248.0		392.0	493.0		785.0	1270.0	1270.0	2150.0	

(4) GS Type: List of Inner Peripheral Lengths (mm)

Inner peripheral length of less than 300		300 or more and less than 600		600 or more and less than 800	800 or more and less than 1000	1000 or more						
Tolerance: ± 2 mm		Tolerance: ± 3 mm		Tolerance: ± 4 mm	Tolerance: ± 5 mm	Tolerance: ± 0.5 %						
147.0	186.0	232.0	274.0	301.0	363.0	428.0	521.0	603.0	714.0	808.0	1006.0	1185.0
150.0	191.0	237.0	276.0	302.0	370.0	429.0	525.0	607.0	715.0	823.0	1011.0	1202.0
151.0	192.0	238.0	278.0	303.0	373.0	432.0	531.0	610.0	727.0	839.0	1025.0	1212.0
152.0	194.0	240.0	280.0	306.0	375.0	434.0	535.0	617.0	737.0	858.0	1031.0	1217.0
155.0	196.0	242.0	283.0	307.0	378.0	440.0	539.0	622.0	743.0	865.0	1036.0	1242.0
156.0	200.0	243.0	285.0	309.0	383.0	445.0	540.0	634.0	750.0	877.0	1051.0	1274.0
159.0	202.0	246.0	286.0	315.0	390.0	453.0	548.0	642.0	758.0	885.0	1061.0	1283.0
160.0	203.0	247.0	287.0	320.0	392.0	456.0	551.0	645.0	763.0	908.0	1070.0	1313.0
162.0	206.0	247.5	288.0	321.0	396.0	459.0	555.0	656.0	768.0	917.0	1074.0	1321.0
164.0	207.0	249.0	290.0	323.0	400.0	462.0	559.0	657.0	772.0	922.0	1077.0	1346.0
165.0	210.0	251.0	292.0	328.0	404.0	466.0	561.0	663.0	778.0	945.0	1081.0	1361.0
168.0	213.0	252.0	294.0	330.0	408.0	470.0	566.0	668.0	793.0	960.0	1084.0	1410.0
169.0	214.0	253.0	299.0	331.0	412.0	473.0	575.0	672.0		970.0	1091.0	1430.0
172.0	216.0	256.0		332.0	413.0	477.0	581.0	677.0		983.0	1100.0	1445.0
174.0	219.0	258.0		341.0	415.0	484.0	586.0	684.0		990.0	1111.0	1462.0
177.0	223.0	262.0		347.0	417.0	495.0	589.0	692.0			1126.0	1493.0
179.0	224.0	265.0		351.0	421.0	497.0	592.0	700.0			1147.0	1509.0
182.0	227.0	269.0		352.0	424.0	505.0	596.0	704.0			1153.0	1548.0
183.0	230.0	272.0		353.0	425.0	507.0	598.0	708.0			1156.0	1563.0
				360.0	427.0	512.0					1174.0	

*If you wish to order a product with a size other than the standard, consult us.

*SEB is built to order; the minimum order quantity is one lot. For details, contact our agencies or our sales representative.

High-Temperature Conveyor and Low-Load Power Transmission Belt

H50 Series

Feature: This belt, which uses highly heat-resistant rubber and seamless woven fabric, is applied to heat-resistant conveyance and low-load power transmission.

Use: Conveying silver-halide sensitized paper, high-temperature pinching conveyance, etc.

Cross Section

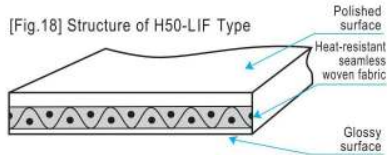

[Fig.18] Structure of H50-LIF Type

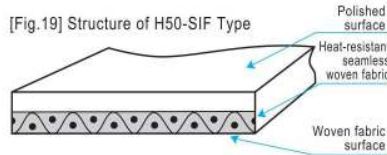

[Fig.19] Structure of H50-SIF Type

Types and Properties

Item	H50-LIF	H50-SIF
1 Structure	Fig. 18	Fig. 19
2 Available width (mm)	5 to 200	5 to 200
3 Standard thickness (mm)	1.0	0.7
4 Rubber material	White fluorine-containing rubber	White fluorine-containing rubber
5 Surface figure	Polished surface	Polished surface
6 Pulley surface figure	Glossy surface	Woven fabric surface
7 Weight	19	11
8 Breaking strength (N/mm width)	24.5	16.7
9 Standard elongation rate (%)	2.0	2.0
10 Axial load at the standard elongation rate under stable conditions (N/mm width)	4.9	4.9
11 Friction coefficient	Top surface	0.4 to 0.8
	Pulley surface	0.5 to 1.0
12 Minimum pulley diameter (mm)	φ 15	φ 15
13 Operating temperature range	-20 to +200	-20 to +200

Standard Dimensional Tolerance

(1) Width (mm)

Width	Tolerance
5 or more and less than 11	±0.3
11 or more and less than 21	±0.5
21 or more and less than 101	±1.0
101 or more	±1.5

(2) Thickness (mm)

Thickness	Tolerance
0.8 or more and less than 1.0	±0.06
1.0 or more	±0.10

(3) H50 Type: List of Inner Peripheral Lengths (mm)

350 or more and less than 500		500 or more and less than 700		700 or more and less than 900	900 or more and less than 1100	1100 or more
Tolerance: ± 3 mm		Tolerance: ± 4 mm		Tolerance: ± 4.5 mm	Tolerance: ± 5.5 mm	Tolerance: ± 0.5 %
352.0	440.0	505.5	642.0	700.0	908.0	1101.0
353.0	446.0	507.5	645.5	703.5	918.0	1112.5
360.0	450.0	513.0	656.0	708.0	922.5	1127.5
364.5	455.0	522.0	658.0	715.0	945.0	1148.0
370.0	459.5	525.5	664.0	715.5	960.0	1155.0
374.0	466.5	532.0	668.5	727.5	971.0	1176.0
375.0	470.0	537.0	672.5	737.5	983.0	1186.0
379.0	473.0	539.5	677.0	744.0	990.0	1203.5
384.0	477.0	545.0	683.0	750.5	1006.0	1213.0
387.0	485.0	548.0	692.0	758.0	1010.5	1218.5
390.5	495.5	551.0		763.0	1026.0	1243.0
393.0	498.0	555.5		769.0	1037.5	1264.0
396.0		560.0		772.0	1052.5	1275.0
400.0		567.0		778.5	1062.0	1284.0
404.5		575.5		793.0	1076.0	1314.5
408.0		581.0		808.0	1082.0	1322.5
412.5		586.5		823.5	1084.5	1346.0
414.0		589.0		839.0	1093.0	1361.0
415.0		592.5		858.5		1411.0
416.0		596.0		877.5		1431.0
418.0		598.5		885.5		1446.5
422.0		603.0				1463.0
424.0		607.0				1494.0
426.5		610.0				1510.0
427.5		617.5				1549.0
432.0		622.5				1564.0
434.0		633.5				

* Each inner peripheral length of H50-SIF Type shown in the list above is obtained when the impregnated surface is placed on the pulley side.

For the inner peripheral length obtained when the impregnated surface is placed in the opposite way, contact us.

* If you wish to order a product with a size other than the standard, consult us.

* SEB is built to order; the minimum order quantity is one lot. For details, contact our agencies or our sales representative.

Selecting Belt

1 Selecting Conditions

When selecting a belt, it is necessary to pay attention to not only the performance and characteristics of the belt but also the use conditions and environment of the machine. Therefore, refer to the following items.

- 1 Use Conditions**
1. Types of motors
 2. Operating condition (Load fluctuation)
 3. Load inertia
 4. Accelerating torque
 5. Number of revolutions (Speed)
 6. Conveyance condition and method
 7. Pulley diameter
 8. Speed ratio
 9. Center distance

- 2 Use Environment**
1. Atmosphere (Oil, water, dust and ozone)
 2. Ambient temperature (during operation and stop)
 3. Ray (Ultraviolet rays)

- 1 Belt Performance**
1. Standard elongation rate
 2. Tension under stable conditions
 3. Rubber material
 4. Tension member structure
 5. Surface friction coefficient
 6. Pitch line position
 7. Minimum pulley diameter
 8. Antistatic performance
 9. Mass

- 2 Use Environment**
1. Tension adjustment (Adjusting/fixing axis)
 2. Pulley shape (Width and crown height)
 3. Selecting belt top/bottom surfaces

2 Selecting Procedures

Fully understand the purpose and conditions of the belt use for selecting the belt type. Then select the belt width according to transmission/conveyance capacity and calculate the required elongation rate.

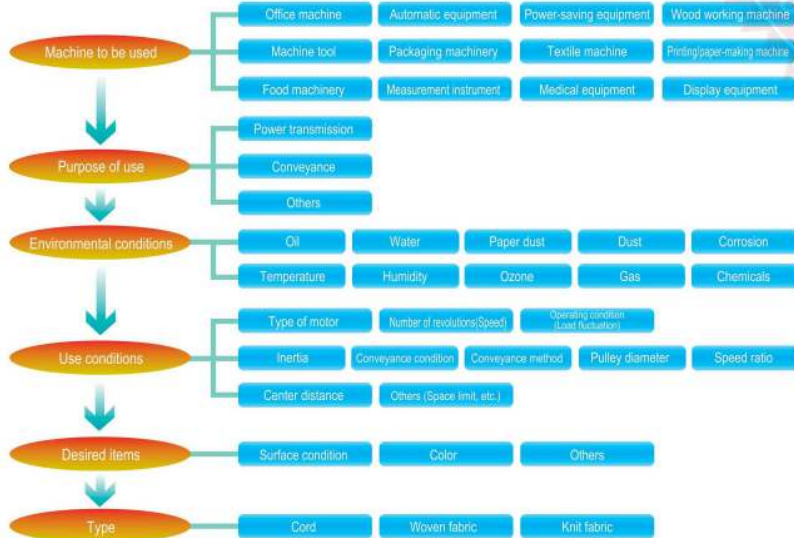

3 Selecting Type

When selecting the belt type, examine the use, use environment and the difficulty level of maintenance/inspection for the machine using the belt. After fully understanding the features of each belt type, select the most suitable one.

Tension member structure	Seamless knit fabric (Polyester, etc.)	Seamless woven fabric (Polyester, etc.)		Cord (Polyester, etc.)
Major types	N-SMV1/V2, N-LBU, etc.	G15, G30, etc.	F50, F100, etc.	XA, A, B, D, etc.
Major application	Conveyance	Low-load power transmission and conveyance	Medium-load power transmission and conveyance	Power transmission
Strength	High	←————→		Low
Stretch properties	High	←————→		Low

4 Selecting Structure

Code	Main Features and Application
Code starting with the letter "S" (SB, SBC, SBU, etc.)	Pinching a paper sheet between belts for conveyance
Code starting with the letter "L" (LB, LBC, LBU, etc.)	Pinching a hard card between belts for conveyance
Code starting with the letter "P" (PB, PC, etc.)	High-precision power transmission
Code ending with the letter "A" (OBA, etc.)	Used for high-precision power transmission requiring antistatic performance
PSS	Used when both surfaces of the belt are required to be driven
OC	Used for the extremely low-stretch belt that uses glass fiber cord as a tension member
NR, WN	Used when high friction coefficient is required on the back surface

Determine the belt type and structure by examining the applications and the rubber properties mentioned in P 2 and 3.

Design Materials

Transmitted Power Correction Factor Depending on Overload Fluctuation

Motor overload fluctuation		149 % or less			199 % or less			249 % or less			250 % or less		
Environmental conditions		A	B	C	A	B	C	A	B	C	A	B	C
Operating conditions	Smooth	1.2	1.4	1.8	1.4	1.7	2.1	1.6	1.9	2.4	1.8	2.1	2.7
	Nearly smooth	1.3	1.5	1.9	1.5	1.8	2.2	1.7	2.0	2.5	1.9	2.2	2.8
	High impact	1.4	1.7	2.1	1.6	1.9	2.4	1.8	2.1	2.7	2.0	2.4	3.0
	Low impact	1.5	1.8	2.2	1.7	2.0	2.5	1.9	2.2	2.8	2.1	2.5	3.1
	Medium impact	1.6	1.9	2.4	1.8	2.1	2.7	2.0	2.4	3.0	2.2	2.6	3.3

Environmental conditions	A	Normal
	B	Slightly poor
	C	Poor (Attachment of large quantities of oil, etc.)

Types of Motors

- Maximum output: Rated output of 149 % or less**
AC wound motors, DC motors, etc.
- Maximum output: Rated output of 150 – 199 %**
AC wound motors, normal torque motors, etc.
- Maximum output: Rated output of 200 - 249 %**
AC wound motors, DC compound-wound motors, normal torque synchronous motors, etc.
- Maximum output: Rated output of 250 % or more**
DC series-wound motors, high torque synchronous motors, AC single-phase motors, line shaft motors, etc.

Operating Conditions for Machines to Be Used

- Extremely smooth power transmission**
Liquid agitators, blowers, small machine tools, low-load conveyors, etc.
- Nearly smooth power transmission**
Machine tools, line shaft motors, pumps, washing machines, viscous material mixers, etc.
- Power transmission with low impact**
Compressors, generators, wood working machines, elevators, rubber calendars, etc.
- Power transmission with medium impact**
Centrifugal machines, bucket elevators, pulverizers, saw mills, wood working machine, etc.
- Power transmission with high impact**
Crusher mills, piston compressors, pumps, extruders, etc.

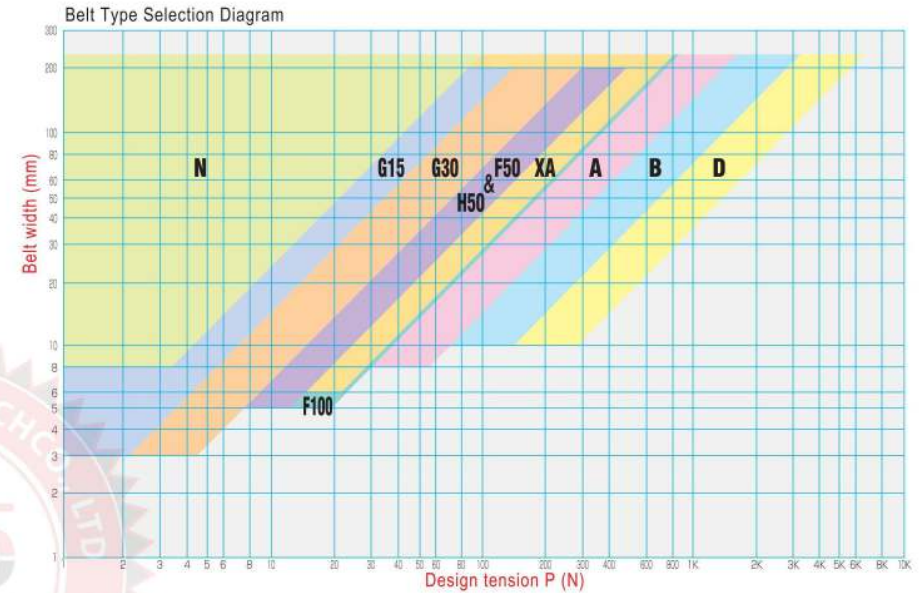

Traction coefficient (λ)

Angle of contact with pulley (°)	70	80	90	100	110	120	130
Traction coefficient (λ)	0.2396	0.2722	0.3042	0.3355	0.3662	0.3960	0.4250
Angle of contact with pulley (°)	140	150	160	170	180	190	200
Traction coefficient (λ)	0.4532	0.4805	0.5069	0.5323	0.5569	0.5805	0.6032
Angle of contact with pulley (°)	210	220	230	240	250	260	270
Traction coefficient (λ)	0.6249	0.6457	0.6656	0.6846	0.7027	0.7200	0.7364

Calculation for Selecting Belt

Design Procedure 1

Calculating the effective tension applied to the belt

Calculating the effective tension from the transmitted power

(1) Calculate the belt speed (V).

$$V \text{ (m/s)} \quad V = \frac{\pi \times D \times n}{60000}$$

D : Circumference ratio
D : Drive pulley diameter (mm)
n : Number of revolutions of the drive pulley (r/min)

(2) Calculate the effective tension (Te), where the transmitted power is kW.

$$Te \text{ (N)} \quad Te = \frac{1000 \times P_m}{V}$$

Pm : Transmitted power (kW)

(2') Calculate the effective tension (Te), where the transmitted power is W.

$$Te \text{ (N)} \quad Te = \frac{P_m'}{V}$$

Pm' : Transmitted power (W)

Calculating the effective tension from the transmission torque (Tr)

(1) When the unit of torque is N-m

$$Te \text{ (N)} \quad Te = \frac{2000 \times Tr}{D}$$

Tr : Torque (N-m)
D : Pulley outer diameter (mm)

(2) When the unit of torque is N-mm

$$Te \text{ (N)} \quad Te = \frac{2 \times Tr'}{D}$$

Tr' : Torque (N-mm)
D : Pulley outer diameter (mm)

Calculating the torque (Tr) caused by inertia

(1) Calculate the torque (Tr) caused by the moment of inertia (J).

$$Tr \text{ (N}\cdot\text{m)} \quad Tr = \frac{J \times (n_1 - n_2)}{9.55 \times t}$$

J : Moment of inertia (kgm²)
n₁-n₂ : Difference in number of revolutions (r/min)
t : Acceleration/deceleration time (S)

(1') Calculate the torque (Tr) caused by GD².

$$Tr \text{ (N}\cdot\text{m)} \quad Tr = \frac{GD^2 \times (n_1 - n_2)}{38.2 \times t}$$

GD² : Flywheel effect (kgf-m²)
n₁-n₂ : Difference in number of revolutions (r/min)
t : Acceleration/deceleration time (S)

(2) Calculate the effective tension (Te) caused by the weight of the conveyed object, during acceleration/deceleration.

$$Te \text{ (N)} \quad Te = m \times \alpha$$

m : Mass (kg)
α : Acceleration/deceleration speed (m/s²)

Design Procedure 2

Calculating the design tension

Obtain the transmitted power correction factor (K1) from the table at Page 24. Then calculate the design tension (P).

$$P \text{ (N)} \quad P = Te \times K_1$$

Design Procedure 3

Selecting the belt type

Select the belt type from the Belt Type Selection Diagram (P. 25)

Design Procedure 4

Calculating the traction coefficient (λ)

Calculate the contact angle θ (rad) of the belt on the pulley, from the pulley layout. Select the appropriate pulley diameter from the speed ratio, the pulley limit diameter, etc. and calculate the contact angle θ (rad) of the belt on the pulley.

Calculate the contact angle θ (rad).

$$\theta \text{ (rad)} = \pi - 2\text{SIN}^{-1} \left[\frac{D-d}{2C} \right]$$

Calculate the contact angle θ (deg).

Then, convert it into the contact angle θ (rad) as follows:

$$\theta \text{ (deg)} = 180^\circ - 2\text{SIN}^{-1} \left[\frac{D-d}{2C} \right]$$

$$\theta \text{ (rad)} = \frac{\theta \text{ (deg)}}{180} \times \pi$$

D : Large pulley diameter (mm)
d : Small pulley diameter (mm)
C : Center distance (mm)

Calculate the traction coefficient (λ).

Obtain the traction coefficient (λ) by the following formula or the proportional calculation (with the use of the table at P. 25).

$$\lambda = \frac{e^{\mu \theta} - 1}{e^{\mu \theta} + 1}$$

μ : Friction coefficient of the pulley surface (0.4 normally used)
θ : Contact angle on the pulley (rad)

Design Procedure 5

Selecting the inner peripheral length of the belt

Calculate the belt length (Lp) for installation.

Obtain the inner peripheral length for installation by using the following formula or the Belt Inner Peripheral Length Nomograph (Pages 30 and 31).

$$L_p \text{ (mm)} \quad L_p = 2C + \frac{\pi(D+d)}{2} + \frac{(D-d)^2}{4C}$$

C : Center distance
D : Large pulley diameter (mm)
d : Small pulley diameter (mm)

Calculate the belt size (Inner peripheral length)

BL by using the elongation rate (ε0).

$$BL \text{ (mm)} \quad BL = L_p + \frac{100 + \epsilon_0}{100} \times L_p$$

ε₀ : Standard elongation rate (%)

Select a belt with the nearest size according to the obtained BL and the inner peripheral length.

Design Procedure 6

Selecting the belt width

Calculate the centrifugal force per unit width (Tf) applied to the belt.

$$T_f = 0.002 \times \gamma \times V^2 \times t \quad \text{(N/mm)}$$

γ : Specific gravity (1.24 normally used)
V : Belt speed (m/s)
t : Belt thickness (mm)

Then, calculate the belt width (W).

$$W' = \frac{P}{(SL - T_f) \times \lambda} \quad \text{(mm)}$$

P : Design tension (N)
SL : Axial load under stable conditions (N/mm)
λ : Traction coefficient

The belt length is set by 5 mm unit;

round the belt length obtained above to the nearest 5 mm.

$$\text{Belt width } W \text{ (mm)} \quad W = (\text{Width set by 5 mm unit}) \geq W'$$

Design Procedure 7

Calculating the required elongation rate of the belt

$$\epsilon = \epsilon_0 \times \frac{W'}{W} \quad (\%) \quad \epsilon_0 : \text{Standard elongation rate} (\%)$$

Design Calculation

Design conditions

- (1) Type of Machine: Cross flow fan
- (2) Motor rated output: 2.2 kW
- (3) Number of revolutions of the original driving axle
- (4) Speed ratio: 1 to 2 deceleration
- (5) Center distance
- (6) Drive pulley diameter
- (7) Belt width limit: 30 mm or less
- (8) Sudden start/stop: None
- (9) Use conditions: Poor conditions not observed in indoor use

Design Procedure 1

Calculating the effective tension applied to the belt

(1) Calculate the belt speed.

$$\text{Belt speed } V \text{ (m/s)} \quad V = \frac{\pi \times D \times n}{60000}$$

$$V = \frac{\pi \times 150 \times 1750}{60000}$$

$$V = 13.74 \text{ (m/s)}$$

π : Circumference ratio
D : Drive pulley diameter (mm)
n : Number of revolutions of the drive pulley (r/min)

(2) Calculate the effective tension applied to the belt.

$$\text{Effective tension } Te \text{ (N)} \quad Te = \frac{1000 \times P_m}{V}$$

$$Te = \frac{1000 \times 2.2}{13.74}$$

$$Te = 160.12 \text{ (N)} \quad P_m : \text{Transmitted power (kW)}$$

Design Procedure 2

Obtaining the design tension

Obtain the transmitted power correction factor (K1) from the table (Page 24).

Transmitted power correction factor (K1) = 2.0

Then, calculate the design tension P.

$$\text{Design tension } P \text{ (N)} \quad P = Te \times K_1$$

$$= 160.12 \times 2.0 = 320.24 \text{ (N)}$$

Design Procedure 3

Selecting the belt type

Select the belt type "B-PB" from the Belt Type Selection Diagram (Page 25)

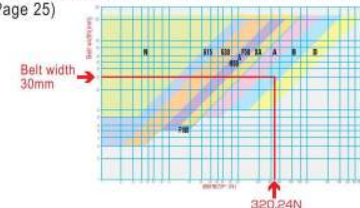

Design Procedure 4

Calculating the traction coefficient (λ)

Select the appropriate pulley diameter according to the speed ratio, the pulley limit diameter, etc.

$$\text{Drive pulley diameter } d$$

$$\text{Driven pulley diameter } D$$

Calculate the contact angle θ (rad) of the belt on the pulley.

$$\theta = \pi - 2\text{SIN}^{-1} \left[\frac{D-d}{2C} \right]$$

$$= \pi - 2\text{SIN}^{-1} \left[\frac{300-150}{2 \times 500} \right] = 2.84 \text{ (rad)}$$

Or, first calculate the contact angle θ (deg) and convert it into the contact angle θ (rad) as follows.

$$\theta \text{ (deg)} = 180^\circ - 2\text{SIN}^{-1} \left[\frac{D-d}{2C} \right]$$

$$\theta \text{ (deg)} = 180^\circ - 2\text{SIN}^{-1} \left[\frac{300-150}{2 \times 500} \right] = 162.7 \text{ (deg)}$$

$$\theta \text{ (rad)} = \frac{\theta \text{ (deg)}}{180} \times \pi = \frac{162.7}{180} \times \pi = 2.84 \text{ (rad)}$$

Obtain the traction coefficient (λ) by the following formula or the proportional calculation (with the use of the table at Page 25).

$$\lambda = \frac{e^{\mu \theta} - 1}{e^{\mu \theta} + 1} = \frac{e^{0.4 \times 2.84} - 1}{e^{0.4 \times 2.84} + 1} = 0.5139$$

μ : Friction coefficient of the pulley surface (0.4 normally used)

Design Procedure 5

Selecting the inner peripheral length of the belt

Obtain the belt length (Lp) for use by using the Belt Inner Peripheral Length Nomograph (P. 30 and 31) or the following formula.

$$L_p = 2C + \frac{\pi(D+d)}{2} + \frac{(D-d)^2}{4C}$$

$$L_p = 2 \times 500 + \frac{\pi(300+150)}{2} + \frac{(300-150)^2}{4 \times 500}$$

$$= 1718.1 \text{ (mm)}$$

D : Center distance (mm)
D : Large pulley diameter (mm)
d : Small pulley diameter (mm)

When using the belt B-PB, the standard elongation rate (ε0) is 1%; calculate the belt size (inner peripheral length BL) as follows:

$$BL = L_p \div \frac{100 + \epsilon_0}{100}$$

$$BL = 1718.1 \div \frac{100+1}{100} = 1701.1$$

Select the nearest size belt from the belt length list. Selected belt size: B-PB 1700(mm)

Design Procedure 6
Selecting the belt width

Calculate the centrifugal force per unit width (Tf) applied to the belt.

$$Tf = 0.002 \times \gamma \times V^2 \times t$$

$$Tf = 0.002 \times 1.24 \times 13.74^2 \times 1.4$$

$$= 0.655 \text{ (N/mm)}$$

γ : Specific gravity
 (1.24 normally used)
 V : Belt speed (m/s)
 t : Belt thickness (mm)

Then, calculate the belt width (W).

$$W = \frac{P}{(SL - Tf) \times \lambda}$$

$$= \frac{320.24}{(29.4 - 0.655) \times 0.5139}$$

$$= 21.7 \text{ (mm)}$$

P : Design tension (N)
 SL : Axial load under stable conditions (N/mm)
 λ : Traction coefficient

The belt length is set by 5 mm unit;
 select the belt width of 25 mm.

Belt width W (mm) : $W = 25 \text{ mm} \geq 21.7 \text{ mm}$

MEMO

Design Procedure 7
Calculating the required elongation rate of the belt (ϵ)

Calculate the required elongation rate (ϵ).

$$\epsilon = \epsilon_0 \times \frac{W}{W'} = 1 \times \frac{21.7}{25} = 0.87 \text{ (\%)}$$

ϵ_0 : Standard elongation rate (%)

The following is the result of selection of the belt.

- Belt type : SE-B-PB
- Belt size : 25"mm x 1700"mm x 1.4"mm
- Drive pulley : ϕ 150mm
- Driven pulley : ϕ 300mm
- Required belt elongation rate : 0.9%

Formulas and Conversion Table

Item	Symbol	Unit	Formula	Remarks
Belt speed	V	m/s	$V = \frac{\pi \times D \times n}{60000}$	D : Drive pulley diameter (mm) n : Number of revolutions of the drive pulley (r/min)
Number of revolutions	n	r/min	$n = \frac{60000 \times V}{\pi \times D}$	
Belt installation length (Open belt)	Lp	mm	$Lp \approx 2C + \frac{\pi(D+d)}{2} + \frac{(D-d)^2}{4C}$	D : Large pulley outer diameter (mm) d : Small pulley outer diameter (mm)
Center distance	C	mm	$C \approx \frac{b + b^2 - 8(D-d)^2}{8}$	$b = 2Lp - \pi(D+d)$
Small pulley contact angle	θ	(deg)	$\theta \text{ (deg)} = 180 - 2\text{SIN}^{-1} \cdot \left[\frac{D-d}{2C} \right]$	D : Large pulley outer diameter (mm) d : Small pulley outer diameter (mm) C : Center distance (mm)
		(deg)	$\theta \text{ (deg)} \approx 180 - \left[\frac{57.3 \times (D-d)}{C} \right]$	
		(rad)	$\theta \text{ (rad)} = \theta \text{ (deg)} \div 180 \times \pi$	
Traction coefficient	λ		$\lambda = \frac{e^{\mu\theta} - 1}{e^{\mu\theta} + 1}$	μ : Friction coefficient θ : (rad)
Number of revolutions of the motor	n	r/min	$n = \frac{120 \times VN}{Po}$	VN : Power frequency Po : Number of motor poles

Item	Symbol	Unit	Formula	Remarks
Effective tension	Te	N	$Te = \frac{1000 \times Pm \text{ (kW)}}{V}$	Pm : Transmitted power (kW or W) V : Belt speed
			$Te = \frac{Pm \text{ (W)}}{V}$	
			$Te = \frac{2000 \times Tr \text{ (N·m)}}{D}$	Tr : Torque (N·m or N·mm) D : Pulley diameter (mm)
			$Te = \frac{2 \times Tr \text{ (N·mm)}}{D}$	
			$Te = m \times \alpha$	m : Mass (kg) α : Acceleration/deceleration speed
Torque	Tr	N·m	$Tr = \frac{9550 \times Pm \text{ (kW)}}{n}$	n : Number of revolutions
			$Tr = \frac{9.55 \times Pm \text{ (W)}}{n}$	
			$Tr = \frac{J \times (n_1 - n_2)}{9.55 \times t}$	J : Moment of inertia $n_1 - n_2$: Difference in number of revolutions t : Acceleration/deceleration time GD ² : Flywheel effect
			$Tr = \frac{GD^2 \times (n_1 - n_2)}{38.2 \times t}$	
Transmitted power	Pm	W or kW	$Pm \text{ (kW)} = \frac{Te \times V}{1000}$	Te : Effective tension V : Belt speed
			$Pm \text{ (W)} = Te \times V$	
			$Pm \text{ (kW)} = \frac{Tr \times n}{9550}$	Tr : Torque
			$Pm \text{ (W)} = \frac{Tr \times n}{9.55}$	

Calculating Belt Inner Peripheral Length

Calculating the inner peripheral length of the belt

In the last step of designing the belt, obtain the inner peripheral length of the belt by using the Belt Inner Peripheral Length Nomograph (Page 31).

<Calculation>

Belt type	: XA-PA
Standard elongation rate	: 1%
Center distance	: 150mm
Small pulley diameter	: φ30mm
Large pulley diameter	: φ50mm

First, add "Small pulley diameter" to "Large pulley diameter" as follows:

$$d+D=30+50=80$$

Read the value of the inner peripheral length that is on the line connecting the center distance (150 mm) and "d + D" (80 mm).

Installation inner peripheral length L_p (mm) $L_p = \text{Approx. } 425 \text{ mm}$

The above value is the approximate installation inner peripheral length. Therefore obtain the required inner peripheral length by dividing the above value by elongation of the belt.

$$\begin{aligned} \text{Inner peripheral length of the belt BL (mm)} \quad BL &= \text{Installation inner peripheral length} \div \left(\frac{\text{Elongation rate (\%)}}{100} \right) \\ &= 425 \div 1.01 \\ &= 420.8 \text{ mm} \end{aligned}$$

Select the nearest inner peripheral length (420 mm) from the List of Inner Peripheral Lengths.

When using this Belt Inner Peripheral Length Nomograph, it is hard to read fractional values and if the speed ratio is high (1: 5 or more), a margin of error becomes large. In such a case, calculate the belt inner peripheral length by the following formula. When calculating the belt length for multi axial power transmission, inform us of the pulley diameter and the coordinate; we will calculate the belt length.

$$\text{Installation inner peripheral length } L_p \text{ (mm)} \quad L_p = 2C + \frac{\pi (D+d)}{2} + \frac{(D-d)^2}{4C}$$

C : Center distance (mm)
D : Large pulley diameter (mm)
d : Small pulley diameter (mm)
 π : Circumference ratio

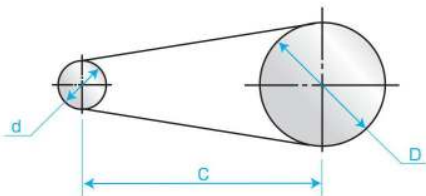

Belt Inner Peripheral Length Nomograph

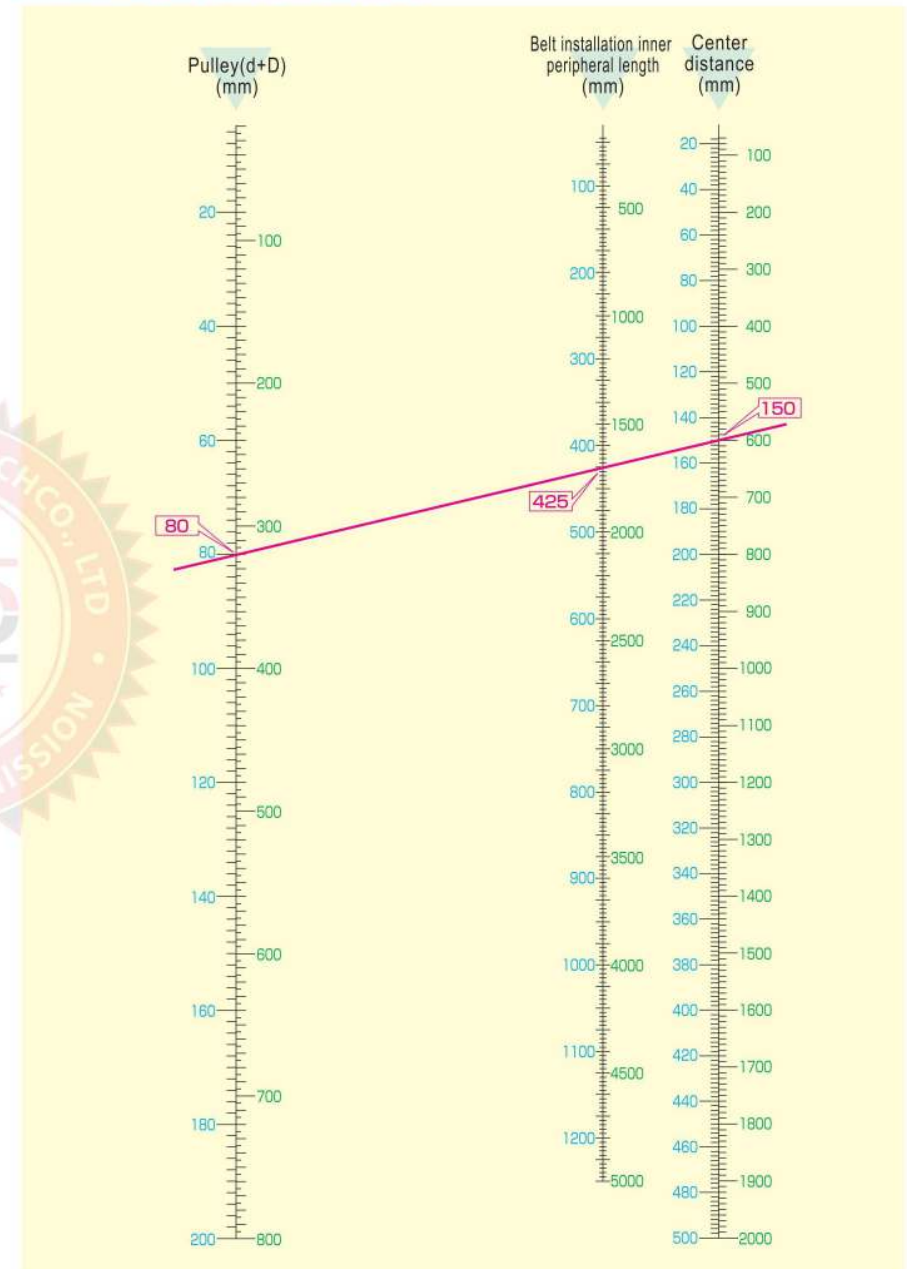

Flat Pulley

Unlike a V-belt, a flat belt, which runs on a pulley surface, has nothing to control its movement in the width direction. Therefore, it is necessary to process the pulley to a shape of "crown", where the center diameter is larger than the diameters on both sides.

Due to the crown processing, difference in speed occurs on the surface of the revolving pulley. When the pulley center diameter is larger, the belt stably runs on the pulley center where the belt speed is high. When the belt and the pulley skid for any cause, speed difference does not occur and the crown effect is not achieved. As a result, the belt deflects from the pulley.

Normally, the pulley is processed to make an arch (crown). (When the pulley is wider, it may be processed to make a trapezoidal shape.)

As a curvature radius becomes larger, the belt tends to run stably. On the other hand, as the curvature radius becomes smaller, the stress distribution of the belt becomes abnormal, causing shortening of the belt life or decrease in transmitted power.

Select an appropriate crown of pulley depending on the type, width and use of the belt.

Recommended Pulley Shape

1. Pulley Width

Make the pulley width larger than the belt width. Obtain the pulley width by the following formula.

$$bp \geq 1.15 \times b + 2 \text{ (mm)}$$

bp : Pulley width
b : Belt width

2. Crown Shape

Select an appropriate crown shape depending on the use and the pulley width.

1 For power transmission

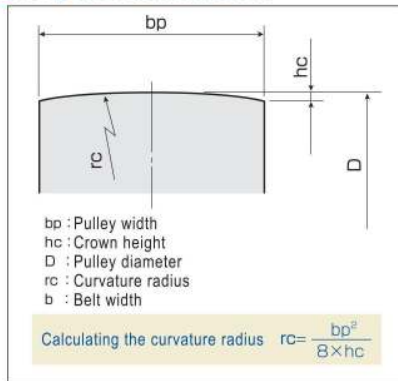

2 For large-width conveyance

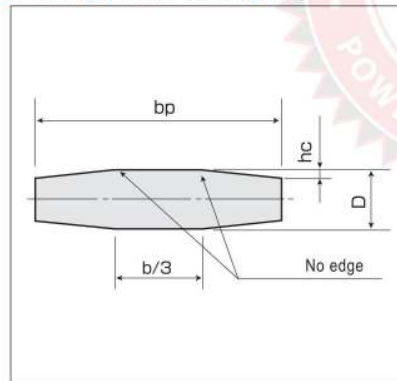

Standard Crown Height for Power Transmission and Large-Width Conveyance (mm)

Pulley diameter (D)	φ5	φ10	φ20	φ30	φ50	φ60	φ80	φ100 or more
Crown height (hc)	Standard 0.10	0.12	0.13	0.14	0.17	0.20	0.24	D×0.003
Upper limit	0.16	0.18	0.20	0.22	0.28	0.32	0.40	D×0.005

3 For pinching conveyance

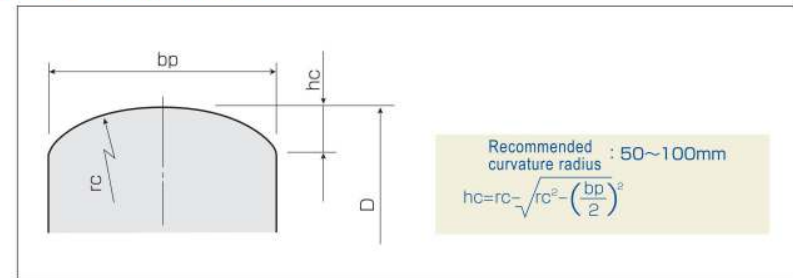

Remarks

The crown height for power transmission and large-width conveyance and the recommended curvature radius mentioned above, which are obtained from performances and experiments, are not the specified values but the reference values.

If the pulley width is larger (50 mm or more) in case of pinching conveyance, the curvature radius may become too small to fit the belt. (In such a case, consult us.)

Use an abrasion-resistant belt with the running surface finish of 1.5 to 6S. When using an aluminum pulley, treat its surface with hard alumite, etc. to prevent abrasion.

Normally, the crown becomes more effective as it becomes higher. However, if the crown becomes excessively high, the belt may not fit the crown, resulting in lack of transmission capacity and worse running conditions.



Do not attach flanges to the pulley.

When the flanges are attached to the pulley, the belt gets caught up on them in most cases, resulting in fatal damage to the belt.

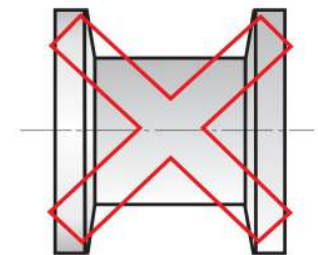

For Correct Use

Precautions for use

■ Installation Tension

The flat belt is a friction transmission belt. For power transmission, the belt requires an appropriate initial tension (installation tension). Excessively low installation tension on the belt may cause skidding and deflection; excessively low tension may cause shortening of the belt life and damage to the bearing. Select an appropriate belt depending on the load and use and apply an appropriate tension to the belt.

■ Measuring the installation tension

● Sonic tensiometer

Previously, we have applied installation tensions to the belts from our experience. As a result, the tension values varied widely. As a result, such an inappropriate installation tension was one of the causes of the mechanical troubles.

The sonic tensiometer shows the accurate tension value by calculating the natural vibration frequency proportional to the tension of the belt span.



Sonic Tensiometer U-507

● Tension Mark System

Put tension marks on two locations of the belt under no-tension condition. While measuring the distance between the tension marks, stretch the belt to obtain the specified elongation rate. Rotate the belt once or twice to stretch it uniformly and check the tension marks.

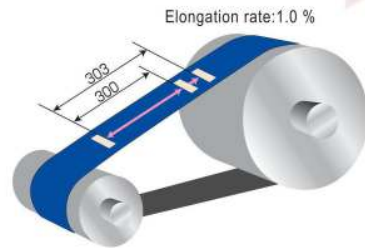

■ Tension Mechanism

Belt Series	Tension Mechanism
XA, A, B, D, GS,	<p>Tension pulley Adjust pulley</p> <p>As a rule, a tension pulley or an adjusting gap is required to apply tension to the belt. The approximate adjusting gap is \pm (Belt length x 0.01).</p>
F50, F100	Normally, you can use the belt in a layout with the fixed center distance. Due to tolerance, however, the load applied to the bearing may become large. It is recommended to set the adjusting gap.
G15, G30	Suitable for the layout where the center distance is fixed; the tension mechanism is not needed.
N	Highly stretchable; you can easily attach this belt in a complicated layout without a tension mechanism.

■ Recommended Elongation Rate

	XA, A, B, D	GS	F50, F100	G15, G30	N
Standard elongation rate	1.0%	0.3%	2.0%	2.0%	5.0%
Elongation rate range	0.5 to 1.0%	0.2 to 0.4%	1.0 to 3.0%	1.0 to 4.0%	3.0 to 7.0%

Note: When attaching the belt with the center distance fixed, choose the standard elongation rate or the medium value of the elongation rate range to select the belt type. Set tolerance of the inner peripheral length within the elongation rate range.

■ Belt Surface

As a pulley surface, use a surface with higher belt friction coefficient.

*[Example] SBU Type: Use a polished surface as a pulley surface.

LBU Type: Use a glossy surface as a pulley surface.



■ Others

Package SEB in a polyethylene bag used for shipping and store it in a cool dark place free from direct sunlight. Lightly wipe the belt with waste cloth impregnated with low-volatile alcohol. Then wipe it with dry waste cloth.

Measures against the Following Problems

Troubleshooting

Power Transmission

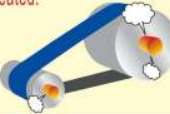
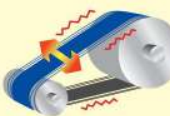
Failure	Failure Diagnosis	Troubleshooting
<p>The belt comes off the pulley.</p> 	The belt deviates at start-up and then returns to normal operation.	<ul style="list-style-type: none"> The starting torque is too high; further tighten the belt if possible. Change the belt type to a high-strength one. Lower the starting load.
	Normal when the load is low; the belt comes off when the load becomes high.	<ul style="list-style-type: none"> The load is higher, compared with the belt effective tension; further tighten the belt if possible. Change the belt type to a high-strength one. Lower the starting load.
	The belt comes off even when the load is low.	<ul style="list-style-type: none"> Correct pulley parallelism. Check that the pulley does not bend. Check that the belt is stretched at the specified elongation rate. Correct the pulley shape.
<p>The specified speed is not achieved.</p> 	Even when further tightening the belt, the revolution speed does not increase.	<ul style="list-style-type: none"> Measure the pulley diameter. When the speed ratio is large, add the pitch line position to the pulley diameter. Measure revolution speed again.
<p>The bearings are excessively heated.</p> 	Check for excessive tension of the belt.	<ul style="list-style-type: none"> When the belt is stretched beyond the specified elongation rate, lower the rate. When the belt width is too large compared with the load, lower the width.
	The belt tension is appropriate.	<ul style="list-style-type: none"> Select appropriate bearings according to the bearing allowable load and revolution speed. Check for shortage of lubricating oil.
<p>Belt deflection</p> 	The belt deflects to the pulley axis. (Snaking)	<ul style="list-style-type: none"> Correct the pulley shape. Check that the belt does not bend locally. Remove foreign mater from the belt if any.
	The belt deflects perpendicularly to the direction of the pulley axis. (Waving)	<ul style="list-style-type: none"> The vibration frequency of the machine resonates with that of the natural vibration frequency of the belt; change the belt tension.

Complicated Layout (Pinching conveyance, etc.)



<p>The belt breaks</p> 	The belt breaks at the early stage of operation.	<ul style="list-style-type: none"> Check that the belt is not excessively stretched for installation or the belt edge is not damaged by the flame edge.
	The belt moves to one side and then breaks. Generally, the belt breaks when it winds around the pulley or contacts the frame. Investigate the cause.	<ul style="list-style-type: none"> Check that the pulley shape is correct. Remove the pulley flange. Check that the gap between the pulleys is not small and the pulleys do not squeeze together. Adjust parallelism of the pulleys. Check that the pulley shaft does not bend. Check that the belt is stretched at the specified elongation rate.

For Safe Use of Products

※Before use, carefully read and follow the safety precautions below.

For safe use, this instruction manual and the product use various symbols and signal words. After fully understanding their meanings, read the safety precautions and follow the instructions.

■ Improper use ignoring the symbols and the signal words may result in the following risks.

Symbol and Signal Word	Severity of Risk
 DANGER	Indicates matters that may lead to imminent risk of death or serious injury if ignored or incorrectly handled.
 WARNING	Indicates matters that may lead to death or serious injury if ignored or incorrectly handled.
 CAUTION	Indicates matters that may lead to injury and physical damage if ignored or incorrectly handled.

1 Function and Performance

- DANGER**
 - Do not use the belt as hoisting or towing equipment.
- WARNING**
 - Do not use the belt beyond the acceptable ranges specified in the Catalogue.
 - When fire and malfunction of the control device are expected due to static electricity generating in the transmission device, use an antistatic belt. Set a neutralization apparatus in the transmission device.
 - Do not use the belt for conveying unpackaged food.

2 Storage and Shipping

- WARNING**
 - Keep fire away.
- CAUTION**
 - When storing and shipping the belts, do not distort them excessively.
 - Store the belts in a well-ventilated, low-humidity place free from direct sunlight. The recommended storage temperature is -10 to +30°C.
 - Store the belts in the shipping packages.

3 Installation and Daily Use

- DANGER**
 - Be sure to put a safety cover over the rotating part including the belt; hair, gloves or clothes may get caught in the belt pulley.
 - Before maintenance, inspection or replacement, be sure to turn off the switch and check that the machine stops.
- WARNING**
 - When cleaning the belt, do not use chemicals harmful to humans.
- CAUTION**
 - After replacing the belt with a new one, perform a test operation to adjust elongation rate and traveling of the belt.
 - When abnormal noise, snaking, deviation, slipping, etc. occur, stop the belt immediately for inspection.

4 Handling Used Belts

- WARNING**
 - Do not leave the belts near fire.
- CAUTION**
 - Do not burn used belts; harmful gasses may be generated.
 - Lawfully dispose of the used belts as industrial waste.



NITTA CORPORATION

4-4-26 Sakuragawa Naniwa-ku, Osaka 556-0022 Japan
Phone:+81-6-6563-1225 Fax:+81-6-6563-1242
<http://www.nitta.co.jp>

NITTA CORPORATION OF AMERICA

7605 Nitta Drive, Suwanee, GA 30024, U.S.A.
Phone:+1-770-497-0212 Fax:+1-770-623-1398
<http://www.nitta.com>

NITTA CORPORATION OF HOLLAND B.V.

Berenkoog 25, 1822 B.H. Alkmaar, The Netherlands
Phone:+31-72-5622234 Fax:+31-72-5613238
<http://www.nitta.nl>

NITTA(SHANGHAI) MANAGEMENT CO., LTD

Room2705, Shengqiao International Building, No.137 Xianxia Road, Shanghai 200051
Phone:+86-21-6229-6000 Fax:+86-21-6229-9606
<http://www.nitta-cn.com>

NITTA CORPORATION INDIA PVT. LTD.

Gat No.191, 192, 193-Plot B, Village Vadhu Khurd, Havelli Taluka, Pune-412 216, INDIA
Phone:+91-20-6731-3400 Fax:+91-20-6731-3401
<http://www.nitta.co.in>

NITTA CORPORATION KOREA OFFICE

Room710, 7F, ShinhanDM Bldg. Mapo-daero 25, Mapo-gu, Seoul, Korea
Phone:+82-2-3274-1252 Fax:+82-2-3274-1253
<http://www.nitta.kr>

NITTA INDUSTRIES EUROPE GmbH

Hansaallee 201,40549 Dusseldorf,Germany
Phone:+49-211-537535-0 Fax:+49-211-537535-35
<http://www.nitta.de>

NITTA CORPORATION OF SINGAPORE PTE LTD

120 Lower Delta Road, #05-07/08
Cendex Centre, Singapore 169208
Phone:+65-6438-8738 Fax:+65-6438-8793
<http://www.nitta.com.sg>
<Thai Liaison Office>Phone:+66-9-0654-9717
<Indonesia Liaison Office>Phone:+62-878-2292-5633

TAIWAN NITTA FILTER CO.LTD.

Headquarters: Chia Hsin Building 10FL Room No. 1005, 96 Chung Shan North Road Section 2, Taipei, Taiwan, R.O.C.
Phone:+886-2-2581-6296 Fax:+886-3-469-0260
<http://www.nitta.com.tw>

NITTA BRASIL

Rua Francisco Mommenshon,50B,Galpão 02 Laranjeiras,Caleiras,São Paulo,Brazil
Phone/Fax:+55-11-4441-2922
<http://www.nitta.com.br>

CONNECT CONVEYOR BELTING INC.

405 Industrial Drive Unit 3-8, Milton, Ontario Canada L9T 5B1
Phone:+1-905-878-5552 FAX:+1-905-878-0344
<http://www.connectbelting.com/>

The specification is subject to change for improvement without notice.

17101000U

Power Transmission and Conveyor Belt
PolyBelt™

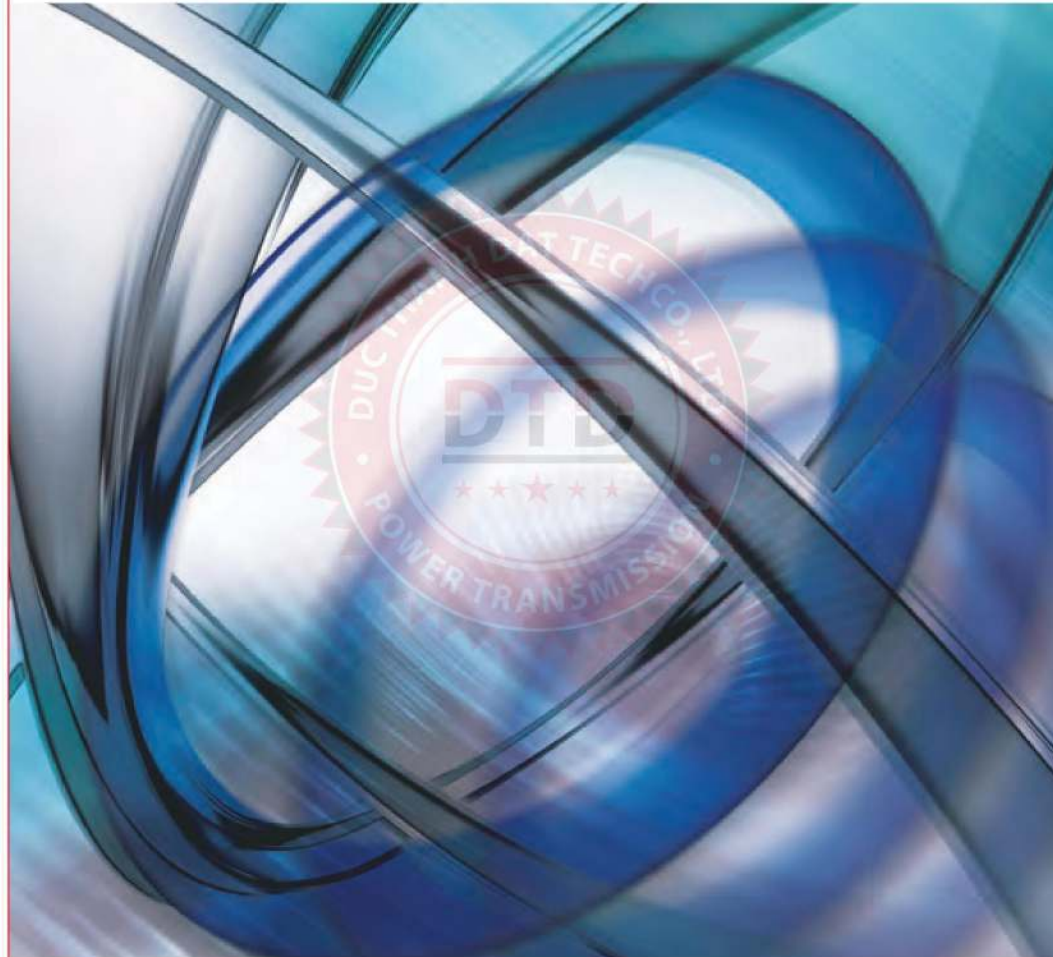

NITTA CORPORATION

Features

Nitta Corporation has developed “PolyBelt” to meet the demands of its customers in the power transmission field, offering a wide variety of types.

These products have delivered proven results in power transmission for industrial machinery used in the textile, paper manufacturing and flour-milling industries. Nitta has also provided the best types of PolyBelt for conveying applications on printing and box-making machines.

PolyBelt, which is basically made up of a combination of thin and strong polyamide film and highly abrasion-resistant special rubber, is widely used in industry.

Nitta’s mission is to deliver high quality and reliable products and to meet the needs of its customers in the fast-changing industrial market.

1 Abrasion resistance

Excellent abrasion resistance achieved due to the stable friction coefficient provided by use of special synthetic rubber (NBR: Acrylonitrile Butadiene Rubber).
(Taber Abrasion Test: 40 mg/1000 times)
*Abrasive wheel used: H22, Load: 5N

2 High-tensile tension member

High-quality stretched polyamide film is used as a tension member to provide high tensile strength.
(Tensile strength of the polyamide film tension member: 300 Mpa (3,000 kgf/cm²) or more)

3 High-speed power transmission

High flex resistance and high-speed power transmission obtained by using a thin and strong tension member to reduce the effect of centrifugal forces.
(Up to 70 m/s available)

4 Antistatic treatment

PolyBelt (except as noted) is subjected to antistatic treatment to obtain low electrostatic potential.
(500 V or less)

5 Wide variety of types

Wide variety of types available to meet the demands in all fields including power transmission and conveyance.

6 Easy endless joining

On-site endless joining of belts is easy with Nitta’s special tools and adhesives.

CONTENTS

	Page
■ Features	2
■ Types and Properties	3 to 6
■ Design Materials	7 to 10
Biaxial Power Transmission Design	7 to 9
Belt Length Calculation Formula	10
Pulley Shape	10
■ Precautions for Use	11 to 13
Troubleshooting for Power Transmission Problems	13
■ For Safe Use of Products	14

Types and Properties

Major Applications	Properties	Belt Type	Total Thickness (mm)	Tension Member Thickness (mm)	Weight (kg/m ²)	Cover Material								Axial load under stable conditions (N/mm width; kg/cm width)		Minimum pulley diameter (mm)		Antistatic property	Standard maximum width (mm)	Temperature range for continuous use (°C) (For intermittent use)		
						Top surface				Bottom surface				At 2% elongation	At 1% elongation	For power transmission	For conveyance					
						Material	Surface configuration	Color	Friction coefficient	Material	Surface configuration	Color	Friction coefficient									
General power transmission Paper feed section of the printing machine Plywood conveyor	Moderate sliding properties on both sides	SG	250	0.8	0.2	0.8	NBR	Weave	Green	0.3	NBR	Weave	Black	0.3	6.0	3.0	25	20	○	300	-20 to +80 (-30 to +100)	
			350	0.95	0.35	0.9		Weave	Green			Weave	Black		10.5	5.2	35	30				
			500	1.1	0.5	1.1		to	Weave			Green	Weave		Black	15.0	7.5	50				40
			750	1.35	0.75	1.4		0.4	Weave			Green	Weave		Black	22.5	11.2	75				50
			1000	1.6	1.0	1.7		Weave	Green			Weave	Black		30.0	15.0	100	60				
Machine tools (automatic lathes, etc.) Dryers (cylinder drying machine, etc.) Small to medium wood working machines Small centrifugal pumps and blowers	Thin rubber especially suitable for flexing/high-speed operation	L	250	1.25	0.2	1.4	NBR	Weave	Blue	0.5	NBR	Weave	Black	0.5	6.0	3.0	25	20	○	300	-20 to +80 (-30 to +100)	
			350	1.4	0.35	1.6		Weave	Blue			Weave	Black		10.5	5.2	35	30				
			500	1.55	0.5	1.8		to	Weave			Blue	Weave		Black	15.0	7.5	50				40
			750	2.2	0.75	2.5		0.6	Weave			Blue	Weave		Black	22.5	11.2	75				50
			1000	2.45	1.0	2.8		(Against iron)	Weave			Blue	Weave		Black	30.0	15.0	100				60
			1500	2.95	1.5	3.4		(Against iron)	Weave			Blue	Weave		Black	45.0	22.5	150				90
Power transmission in industrial machinery (fans, pumps, etc.) Sawmill machines (chippers, etc.) Paper working machines (coaters, etc.) Other power transmission Cut-proof conveyors (thin-plate conveyors, etc.)	Standard type Suitable for normal operating conditions	M	250	2.2	0.2	2.4	NBR	Weave	Blue	0.5	NBR	Weave	Black	0.5	6.0	3.0	25	25	○	300	-20 to +80 (-30 to +100)	
			350	2.35	0.35	2.6		Weave	Blue			Weave	Black		10.5	5.2	35	35				
			500	2.5	0.5	2.7		to	Weave			Blue	Weave		Black	15.0	7.5	50				40
			750	2.75	0.75	3.0		0.6	Weave			Blue	Weave		Black	22.5	11.2	75				50
			1000	3.0	1.0	3.3		(Against iron)	Weave			Blue	Weave		Black	30.0	15.0	100				60
			1500	3.5	1.5	4.0		(Against iron)	Weave			Blue	Weave		Black	45.0	22.5	150				90
			2000	4.0	2.0	4.6		(Against iron)	Weave			Blue	Weave		Black	60.0	30.0	200				120
Compressors Rolling machines Paper tube winding machines Abrasion-resistant conveyors (building material conveyors, etc.)	Highly abrasion/impact resistant thick rubber cover is used. Suitable for severe operating conditions	H	500	3.5	0.5	3.8	NBR	Weave	Blue	0.5	NBR	Weave	Black	0.5	15.0	7.5	50	50	○	300	-20 to +80 (-30 to +100)	
			750	3.75	0.75	4.1		to	Weave			Blue	Weave		Black	22.5	11.2	75				60
			1000	4.0	1.0	4.4		0.6	Weave			Blue	Weave		Black	30.0	15.0	100				75
			1500	4.5	1.5	5.0		(Against iron)	Weave			Blue	Weave		Black	45.0	22.5	150				120
			2000	5.0	2.0	5.6		(Against iron)	Weave			Blue	Weave		Black	60.0	30.0	200				160
		MH	2500	5.0	2.5	6.0	NBR	Weave	Blue	0.5	NBR	Weave	Black	0.5	75.0	37.5	250	—	○	300		
			3000	5.5	3.0	6.5		to	Weave			Blue	Weave		Black	90.0	45.0	300				—
4000	6.5		4.0	7.6	(Against iron)	Weave		Blue	Weave			Black	120.0		60.0	400	—					

Major Applications	Properties	Belt Type		Total Thickness (mm)	Tension Member Thickness (mm)	Weight (kg/m ²)	Cover Material								Axial load under stable conditions (N/mm width; kg/cm width)		Minimum pulley diameter (mm)		Antistatic property	Standard maximum width (mm)	Temperature range for continuous use (°C) (For intermittent use)
							Top surface				Bottom surface				At 2% elongation	At 1% elongation	For power transmission	For conveyance			
							Material	Surface configuration	Color	Friction coefficient	Material	Surface configuration	Color	Friction coefficient							
Corrugated board machines (Paper feeding to and discharging from the rotary cutter)	Highly scratch/abrasion resistant surface material used	CBX-7S		4.2	0.75	2.5	Artificial leather	Flat and smooth	Gray	0.4 to 0.5 (Against carbond)	Artificial leather	Flat and smooth	Gray	0.2 to 0.25 (Against SUS)	—	15.0	—	75	—	300	-20 to +80
Box making machines (Counter eject)	High gripping force and abrasion resistance	CBE-20		Approx.7.0	—	5.9	NBR	Rough top	Blue	Approx. 1.0 (Against carbond)	Polyester	Canvas	Black	0.2 to 0.25 (Against SUS)	—	6.0 (0.5%)	—	100	○	300	-20 to +80
For conveying cardboard boxes	Table-supported high speed conveyance possible	CBG-7S		3.5	0.75	3.5	NBR	Rough	Blue	0.7 to 0.8 (Against carbond)	Polyamide	Canvas	Blue	0.2 to 0.25 (Against SUS)	—	15.0	—	75	○	300	-20 to +80
Conveying cardboard boxes Conveying plywood	High conveyance capacity achieved due to rough top cover Suitable for severe operating conditions	NRT	0	Approx.5.5	—	4.8	NBR	Rough top	Blue	Approx. 1.0 (Against carbond)	Polyester	Canvas	White	0.2 to 0.25 (Against SUS)	—	1.3	—	100	○	300	-20 to +80 (-30 to +100)
			100	Approx.4.5	—	3.6	NBR	Rough top	Blue	Approx. 1.0 (Against carbond)	Polyester	Canvas	White	0.2 to 0.25 (Against SUS)	—	6.0 (0.5%)	—	50	○	300	
			300	Approx.6.5	—	6.5	NBR	Rough top	Blue	Approx. 1.0 (Against carbond)	Polyester	Canvas	White	0.2 to 0.25 (Against SUS)	—	6.0 (0.5%)	—	100	○	300	
			500	Approx.6.0	0.5	5.6	NBR	Rough top	Blue	Approx. 1.0 (Against carbond)	NBR	Canvas	Black	0.2 to 0.25 (Against SUS)	—	7.5	—	90	○	300	
		RT	300	Approx.7.0	—	6.5	NBR	Rough top	Blue	Approx. 1.0 (Against carbond)	Polyester	Canvas	White	0.2 to 0.25 (Against SUS)	—	6.0 (0.5%)	—	100	○	300	
Printer paper feed	Top surface has high friction coefficient Bottom surface has excellent sliding properties	IRTA	350	1.15	0.35	1.2	NBR	Weave	Green	0.5 to 0.6	Polyamide	Canvas	Blue	0.2 to 0.3	10.5	5.2	—	30	○	300	-20 to +80
		KCS	350	1.1	0.35	0.8	NBR	Weave	Black	0.3 to 0.4	Polyamide	Canvas	Blue	0.2 to 0.3	10.5	5.2	—	30	○	300	(-30 to +100)
Folder gluer Conveying plywood	High conveyance capacity achieved due to rubber properties	XH	500-3	3.0	0.5	3.4	NBR	Weave	Blue	—	NBR	Weave	Blue	—	15.0	7.5	—	50	○	300	-20 to +80 (-30 to +100)
			500-3.5	3.5	0.5	3.9	NBR	Weave	Blue	0.8	NBR	Weave	Blue	0.7	15.0	7.5	—	55	○	300	
			500-4	4.0	0.5	4.3	NBR	Weave	Blue	to	NBR	Weave	Blue	to	15.0	7.5	—	60	○	300	
			500-6	6.0	0.5	7.4	NBR	Weave	Blue	0.9	NBR	Weave	Blue	0.8	15.0	7.5	—	80	○	300	
			750-4	4.0	0.75	4.4	NBR	Weave	Blue	—	NBR	Weave	Blue	(Against SUS)	22.5	11.2	—	75	○	300	
			1000-4	4.0	1.0	4.4	NBR	Weave	Blue	—	NBR	Weave	Blue	—	30.0	15.0	—	75	○	300	
Table-supported conveyor Stopper conveyor	Excellent sliding on both surfaces	TTA	500N	1.3	0.5	1.2	Polyamide	Canvas	Blue	0.2 to 0.3	Polyamide	Canvas	Blue	0.2 to 0.3	15.0	7.5	—	40	—	300	-20 to +80
			1000N	1.8	1.0	1.7	Polyamide	Canvas	Blue	0.2 to 0.3	Polyamide	Canvas	Blue	0.2 to 0.3	30.0	15.0	—	60	—	300	(-30 to +100)
		TTB	1000	2.8	1.0	2.5	Polyamide	Canvas	Blue	0.2 to 0.3	Polyamide	Canvas	Blue	0.2 to 0.3	30.0	15.0	—	60	—	300	
Table-supported conveyor	Excellent sliding on one surface	GLTB	500	2.05	0.5	2.0	NBR	Weave	Blue	0.5 to 0.6	Polyamide	Canvas	Blue	0.2 to 0.3	15.0	7.5	—	40	○	300	-20 to +80
			1000	2.75	1.0	2.6	NBR	Weave	Blue	0.5 to 0.6	Polyamide	Canvas	Blue	0.2 to 0.3	30.0	15.0	—	60	○	300	(-30 to +100)
		GMTB	1000	3.0	1.0	2.9	NBR	Weave	Blue	0.5 to 0.6	Polyamide	Canvas	Blue	0.2 to 0.3	30.0	15.0	—	60	○	300	
Sloping conveyor	High conveyance capacity achieved due to rough surface of belt	TW	250	1.8	0.2	1.5	NBR	Rough weave	Blue	—	NBR	Weave	Black	0.5 to 0.6	6.0	3.0	—	25	○	300	-20 to +80
			500	2.1	0.5	1.9	NBR	Rough weave	Blue	—	NBR	Weave	Black	0.5 to 0.6	15.0	7.5	—	40	○	300	(-30 to +100)
		TWH	500	3.8	0.5	3.8	NBR	Rough weave	Blue	—	NBR	Weave	Black	0.5 to 0.6	15.0	7.5	—	40	○	300	

Design Materials

1. Biaxial Power Transmission Design

(1) Select the belt type according to the design power and the small pulley rotation speed shown in Table 1 below.

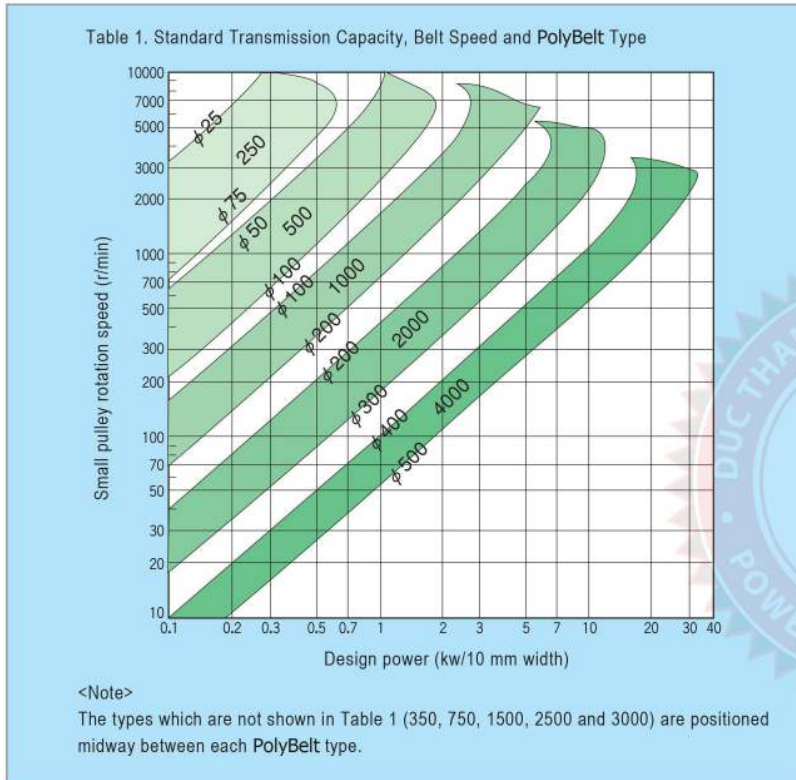

(2) Calculate the belt speed (V) by using the pulley diameter and rotation speed.

$$v \text{ (m/s)} = \frac{\pi \cdot d \cdot n}{60 \times 1000}$$

d: Drive pulley diameter (mm)
n: Drive rotation speed (r/min)

(3) Calculate the effective tension (Te) by using the transmission power and the belt speed.

$$T_e \text{ (N)} = \frac{1000 \times P}{v}$$

P: Transmission power (kw)

(4) Calculate the pulley contact angle (θ) (for the open belt drive).

$$\theta \text{ (deg)} = 180^\circ - \frac{57(D - d)}{C}$$

D: Large pulley diameter (mm)
d: Small pulley diameter (mm)
C: Center distance (mm)

(5) Obtain the traction coefficient (λ) from Table 2 below.

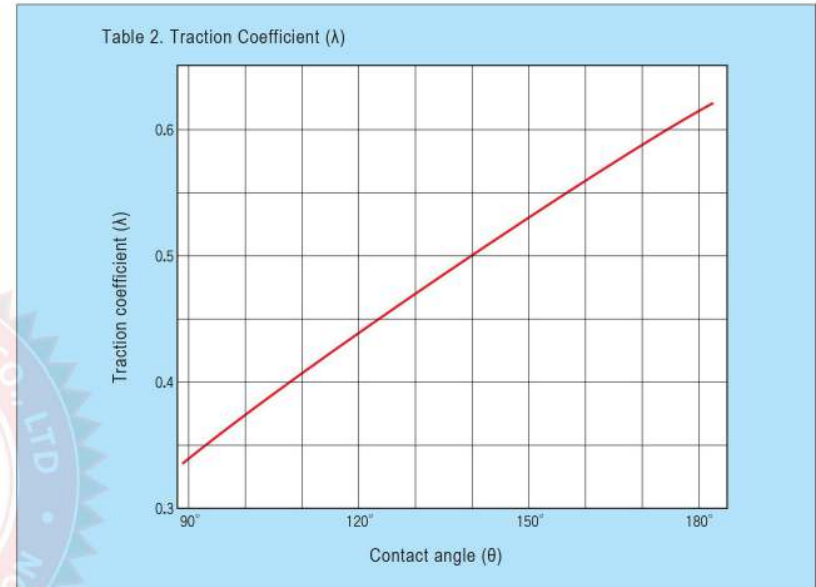

(6) Select the load reserve factor (K) from Table 3 below.

Table 3. Load Reserve Factor (K)

Use conditions	Normal condition	Environment with oil and dust
Excessively light start-up load; small load fluctuation (Belt conveyors and small centrifugal pumps)	1.3	2.4
Light start-up load; small load fluctuation (Printing machines and wood working machines)	1.5	2.7
Heavy start-up load; large load fluctuation (Printing machines, pressing machines and rolling machines)	2.0	3.6

(7) Calculate the approximate axial load (2To).

$$2T_o \text{ (N)} = T_e \times \frac{K}{\lambda}$$

(8) Calculate the belt width limit (b).

$$b \text{ (mm)} \leq \frac{(bp - 10)}{1.1}$$

bp: Pulley width (mm)

Round the calculated belt width to the nearest 5 mm.

(9) Obtain the centrifugal constant from Table 4 below. Then calculate the centrifugal tension (t_c) using the following calculation formula.

<Calculation formula> Centrifugal tension (t_c) = Centrifugal tension constant x Belt thickness (h) (mm)

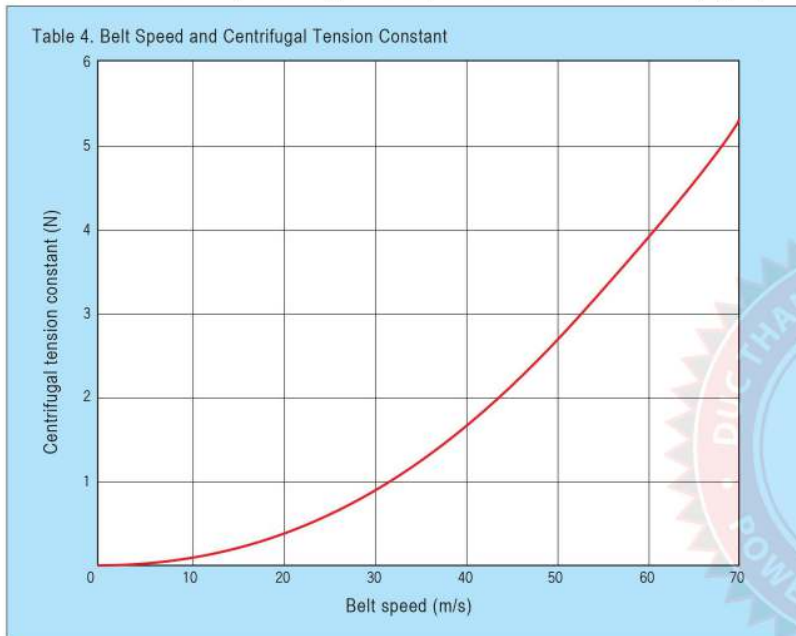

(10) Calculate the axial load ($2t_0$) per unit width (N/mm width).

$$2t_0(\text{N/mm width}) = \frac{2T_0}{b} + 2t_c$$

(11) Calculate the elongation rate (ϵ) of the selected belt.

$$\epsilon = \frac{2t_0}{2t_0(2\%)} \times \epsilon'' \quad \epsilon'' : \text{Standard elongation rate (2\%)} \\ 2t_0(2\%) : \text{Axial load under stable conditions (N/mm width) at 2\% elongation}$$

The allowable belt elongation rate is 1 - 3 %.

When the belt elongation rate is outside this range, take the following measures.

a. Change the belt type. b. Change the belt width.

(12) Calculate the axial load (F) by using the belt tension.

$$\text{During operation stop: } F_s(\text{N}) = 2t_0 \times \frac{\epsilon}{2} \times b \times \sin \frac{\theta \times \pi}{2 \times 180^\circ}$$

$$\text{During operation: } F_r(\text{N}) = \left(2t_0 \times \frac{\epsilon}{2} - 2t_c \right) \times b \times \sin \frac{\theta \times \pi}{2 \times 180^\circ}$$

(Note) For multiaxial power transmission and conveyance, please consult Nitta.

2. Belt Length Calculation Formula

Calculate the inner peripheral length (L_i) as follows:

$$\text{Inner peripheral length (A)} \\ L_i(\text{mm}) = 2C + \frac{\pi}{2}(D+d) + \frac{(D-d)^2}{4C}$$

$$\text{Inner peripheral length (B)} \\ L_i(\text{mm}) = 2C + \frac{\pi}{2}(D+d) + \frac{(D+d)^2}{4C}$$

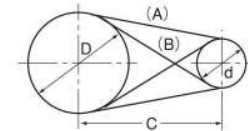

The length of PolyBelt is determined according to the pitch length (L_c). Convert " L_i " obtained above into " L_c ".

$$\text{Pitch length } L_c = L_i + \pi h \quad h : \text{Belt thickness (mm)}$$

When the center distance is fixed and there is no tension pulley in the device, shorten the belt length by the elongation rate as shown in the calculation formula below.

$$\text{Belt length (mm)} = \frac{L_c}{1+E} \quad E = \frac{\epsilon}{100} \quad \epsilon : \text{Elongation rate (\%)}$$

(Note) Please inform Nitta of the pulley diameter and the coordinates; we will calculate the belt length for multiaxial power transmission.

3. Pulley Shape

(1) Calculate the pulley width (bp) from the following formula.

$$bp(\text{mm}) = 1.1b + 10\text{mm} \quad b = \text{Belt width (mm)}$$

(2) Obtain the pulley crown (hc) from Table 5.

Table 5. Standard Crown hc (mm)

Pulley diameter	30~150	151~300	301~700	701~1000	1001~1500	1501 or more
30~125	0.8	1.2	1.3	1.7	2.0	2.5
126~260	1.0	1.3	1.5	2.0	2.3	2.8
261~400	1.1	1.4	1.6	2.2	2.5	3.0

(3) Calculate the curvature radius (rc) from the following formula.

$$rc(\text{mm}) = \frac{bp^2}{8hc}$$

(4) The pulley surface finish is required to be 6.3S or more.

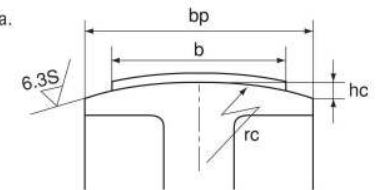

(5) Belt speed and pulley material

Belt speed	30 m/s or less	30 to 50m/s	50 m/s or more
Pulley material	Cast iron, aluminum, mild steel	Cast iron or mild steel	Mild steel

(6) As a rule, do not attach a flange to the pulley.

Precautions for Use

The following are precautions for using PolyBelt.

Belt Tension

Measure the tension mark and stretch the belt to obtain the specified elongation rate. Rotate the belt once or twice to stretch it uniformly and check the tension mark.

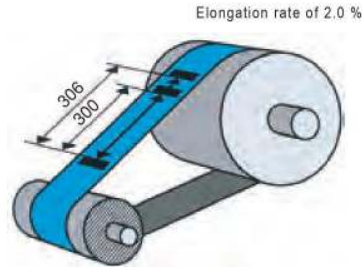

Crossed Belt Drive

PolyBelt is highly abrasion resistant. In order to lengthen the belt life, insert a rotator at the intersection of the belt.



Belt Shifters

Use rotary belt shifters. If the shifters do not rotate, belt abrasion is accelerated. Set the shifters at the positions where the belt enters the driven pulley. When selecting the belt type, consider the shifting property as well as the transmission calculation.

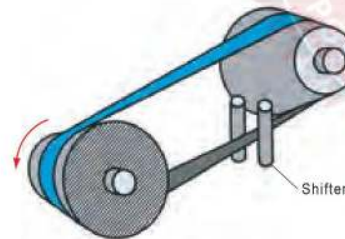

Attaching the Belt

When attaching the belt, use a center-distance adjuster. If the adjuster is not available, cover the pulley edges with waste cloth, etc. to prevent damage to the belt.

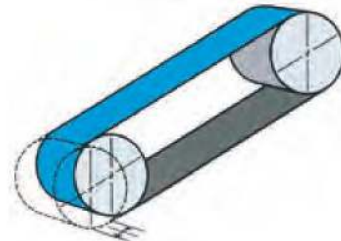

Belt Elongation Rate

The maximum allowable elongation rate for PolyBelt is 3 %. When the belt elongation rate is more than 3 %, use the next highest rank of belt type or a wider belt.

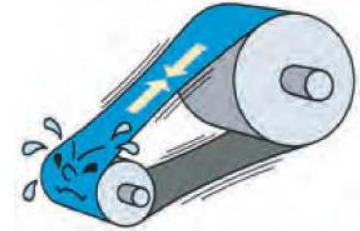

Minimum Pulley Diameter

The minimum pulley diameters of PolyBelt for conveyance are listed in "Types and Properties" on P. 3 to 6. When the belt speed is 5 m/s or less, the minimum pulley diameter for conveyance is in effect.

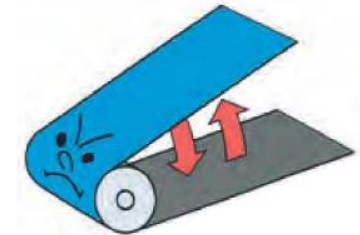

Resistance to Chemicals

PolyBelt is not affected by wetting and drying, machine oil, steam, fat, benzine, etc. However, be aware that PolyBelt is affected by concentrated acids, phenols, ketones and alcohol.

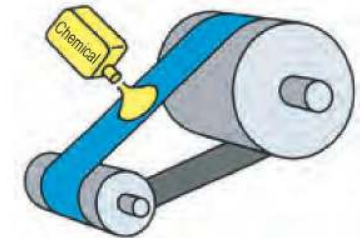

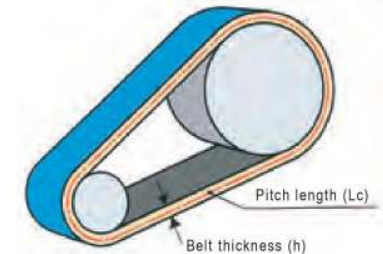

Belt Length

PolyBelt is manufactured according to pitch length. When ordering the belt, specify the pitch length. When ordering the belt to be set at a location where the center distance is not adjustable, specify the pitch length shortened in advance by the specified elongation rate. (See P. 10.)



Troubleshooting for Power Transmission Problems

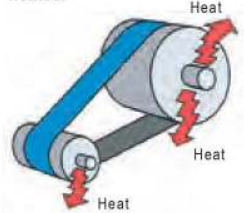
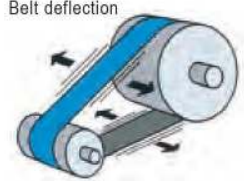

When any of the following failures occur, troubleshoot as follows:

Failure	Failure Diagnosis	Troubleshooting
 <p>The belt comes off the pulley.</p>	The belt deviates at start-up and then returns.	<ul style="list-style-type: none"> The starting torque is too high; tighten the belt further or lower the starting load.
	Normal performance when the load is low; the belt comes off under high load.	<ul style="list-style-type: none"> The load is high; tighten the belt further or lower the load.
	The belt comes off even when the load is low.	<ul style="list-style-type: none"> Correct the pulley parallelism. Tighten the part where the belt comes off. If the tension pulley is used, tilt its axis.
 <p>The specified speed is not reached.</p>	When further tightening the belt, the rotation speed does not increase.	<ul style="list-style-type: none"> Measure the pulley diameter. When the speed ratio is large, add the belt thickness to the pulley diameter. Measure the rotation speed of the driver.
	When further tightening the belt, the rotation speed increases.	<ul style="list-style-type: none"> Check for excessive load. Check the belt tension and the tension rate. Recheck that the belt transmission capacity is appropriate for the load. In an excessively high temperature environment, tighten the belt further.
 <p>The bearings are excessively heated.</p>	Check for excessive tightening of the belt.	<ul style="list-style-type: none"> Check the tension mark or measure the tension with a tensiometer. If the tension is too high, loosen the belt. If the belt is too wide for the load, narrow the belt width.
	The belt tension is appropriate.	<ul style="list-style-type: none"> Select appropriate bearings according to the bearing allowable load and rotation speed. Check for a shortage of lubricating oil.
 <p>Belt deflection</p>	The belt deflects to the pulley axis. (Snaking)	<ul style="list-style-type: none"> When slight snaking of the belt affects functionality, check that the belt is not bent.
	The belt deflects perpendicularly to the direction of the pulley axis. (Waving)	<ul style="list-style-type: none"> The vibration frequency of the machine resonates with that of the natural vibration frequency of the belt; change the belt tension.

For Safe Use of Products

※Before use, carefully read and follow the safety precautions below.

For safe use, this instruction manual and the product use various symbols and signal words. After fully understanding their meanings, read the safety precautions and follow the instructions. ■Improper use ignoring the symbols and the signal words may result in the following risks.

Symbol and Signal Word	Severity of Risk
 DANGER	Indicates matters that may lead to imminent risk of death or serious injury if ignored or incorrectly handled.
 WARNING	Indicates matters that may lead to death or serious injury if ignored or incorrectly handled.
 CAUTION	Indicates matters that may lead to injury and physical damage if ignored or incorrectly handled.

1. Function and Performance

DANGER

- Do not use the belt as hoisting or towing equipment.

WARNING

- Do not use the belt beyond the acceptable ranges specified in the Catalogue.
- When fire and malfunction of the control device are expected due to static electricity generating in the transmission device, use an antistatic belt. Set a neutralization apparatus in the transmission device.
- Do not use the belt for conveying unpackaged food.

2. Storage and Shipping

WARNING

- Keep fire away.
- Belt is combustible; do not store or use it near fire or a high-temperature heat source.
- When storing heavy belts, fix them by appropriate jigs or stoppers to prevent falling or rolling.

CAUTION

- When storing and shipping the belts, do not distort them excessively.
- Store the belts in a well-ventilated, low-humidity place free from direct sunlight. The recommended storage temperature is -10 to +30°C.
- Store the belts in the shipping packages.

3. Installation and Daily Use

DANGER

- Be sure to put a safety cover over the rotating part including the belt; hair, gloves or clothes may get caught in the belt pulley.

- Before maintenance, inspection or replacement, be sure to turn off the switch and check that the machine stops.

WARNING

- When cleaning the belt, do not use chemicals harmful to humans.

CAUTION

- After replacing the belt with a new one, perform a test operation to adjust tension, elongation rate and operation.
- Do not attach the belt forcibly; use a motor slide, a tension pulley or a special pulling device.
- When abnormal noise, snaking, deviation, slipping, etc. occur, stop the belt immediately for inspection.

4. Installation, Endless Processing, etc.

WARNING

- When using solvent or adhesive, fully ventilate the workplace. Keep fire away.

CAUTION

- Perform endless joining of belts by using the materials, the methods and the procedures specified by Nitta.

5. Handling Used Belts

WARNING

- Do not leave the belts near fire.

CAUTION

- Do not burn used belts; harmful gasses may be generated.
- Lawfully dispose of the used belts as industrial waste.



NITTA CORPORATION

4-4-26 Sakuragawa Naniwa-ku, Osaka 556-0022 Japan
Phone:+81-6-6563-1225 Fax:+81-6-6563-1242
<http://www.nitta.co.jp>

NITTA CORPORATION OF AMERICA

7605 Nitta Drive, Suwanee, GA 30024, U.S.A.
Phone:+1-770-497-0212 Fax:+1-770-823-1398
<http://www.nitta.com>

NITTA CORPORATION OF HOLLAND B.V.

Berenkoog 25, 1822 B.H. Alkmaar, The Netherlands
Phone:+31-72-5622234 Fax:+31-72-5613238
<http://www.nitta.nl>

NITTA(SHANGHAI) MANAGEMENT CO., LTD

Room2705, Shenggao International Building, No.137 Xianxia Road, Shanghai 200051
Phone:+86-21-6229-6000 Fax:+86-21-6229-9606
<http://www.nitta-cn.com>

NITTA CORPORATION INDIA PVT. LTD.

Gat No.186, Village Fulgaon, Taluka Haveli, Pune, Maharashtra 412216, INDIA
Phone:+91-20-8731-3400 Fax:+91-20-8731-3401
<http://www.nitta.co.in>

NITTA CORPORATION KOREA OFFICE

Room710, 7F, ShinhanDM Bldg. Mapo-daero 25, Mapo-gu, Seoul, Korea
Phone:+82-2-3274-1252 Fax:+82-2-3274-1253
<http://www.nitta.kr>

NITTA INDUSTRIES EUROPE GmbH

Hansaallee 201, 40549 Dusseldorf, Germany
Phone:49-211-537535-0 Fax:+49-211-537535-35
<http://www.nitta.de>

NITTA CORPORATION OF SINGAPORE PTE LTD

120 Lower Delta Road, #05-07/08
Cendex Centre, Singapore 169208
Phone:+65-6438-8738 Fax:+65-6438-8793
<http://www.nitta.com.sg>

<Thai Liaison Office>Phone:+66-9-0654-9717
<Indonesia Liaison Office>Phone:+62-878-2292-5633

TAIWAN NITTA FILTER CO.LTD.

Headquarters: Chia Hsin Building 10FL Room No. 1005, 96 Chung Shan North Road Section 2, Taipei, Taiwan, R.O.C.
Phone:+886-2-2581-6296 Fax:+886-3-469-0260
<http://www.nitta.com.tw>

NITTA BRASIL

Rua Francisco Mommenshon, 50B, Galpão 02
Laranjeiras, Caeiras, São Paulo, Brazil
Phone/Fax:+55-11-4441-2922
<http://www.nitta.com.br>

CONNECT CONVEYOR BELTING INC.

405 Industrial Drive Unit 3-8, Milton, Ontario Canada L9T 5B1
Phone:+1-905-878-5552 FAX:+1-905-878-0344
<http://www.connectbelting.com/>