

MD 821 Chain Series

Straight Running-Double Hinge Chains

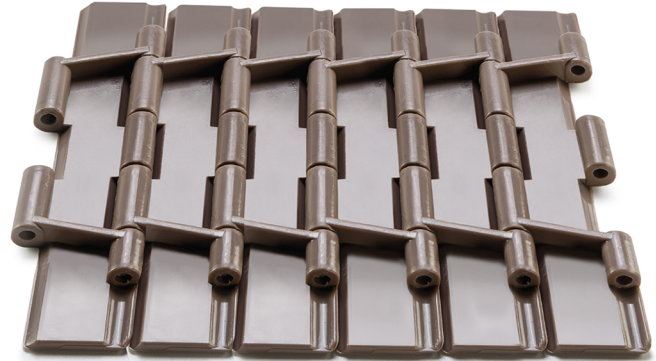
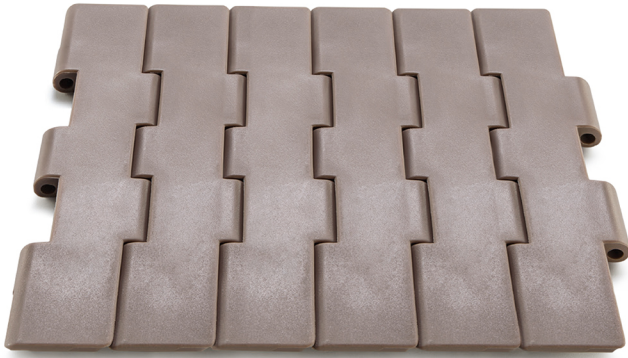

MD 821 Technical Information

MD 821 SERIES STRAIGHT RUNNING - DOUBLE HINGE CHAINS

PRODUCT CODE	WIDTH (W)		PLATE THICKNESS (S)	TENSILE STRENGTH		WEIGHT
	mm	inch	mm	Kg/m	N/m	Kg/m
MD 821-K750-LF	190,5	7,50	4,8	270	2700	2,70
MD 821-K1000-LF	254,0	10,00	4,8	270	2700	3,10
MD 821-K1200-LF	304,8	12,00	4,8	270	2700	3,40

* Self-lubricating low friction acetal resin, brown-coloured.

* Pins in special chrome-nickel 304 stainless steel

* Standard packing lengths = 80 pitches= 3,048 m

MD 821 Technical Drawings

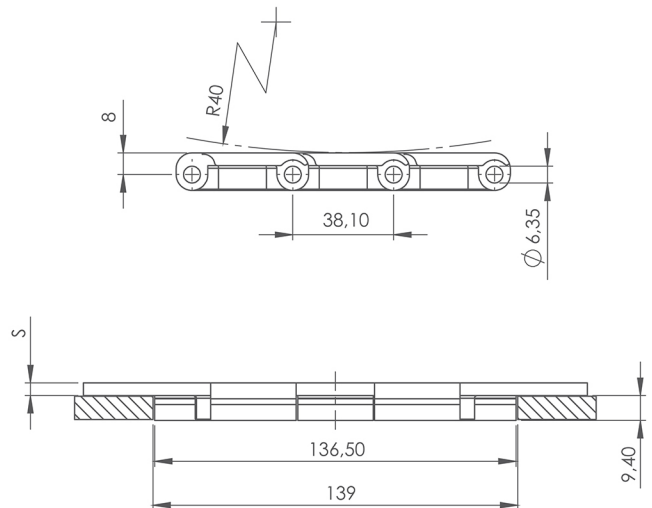
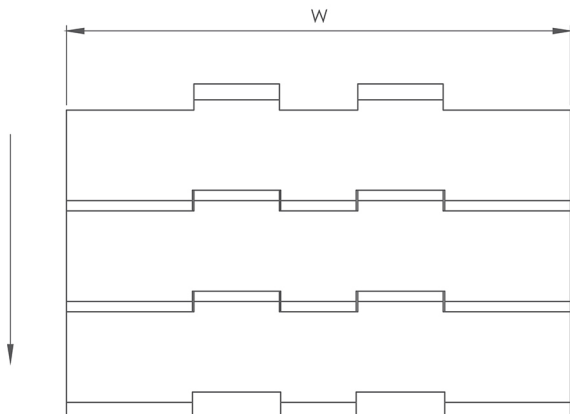

MD 820 Sprockets Technical Drawings

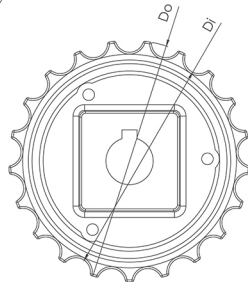

Classic Sprocket Series MD820

Product Code	Number of Teeth	Do (mm)	Di (mm)	Round Bore (Ø)
MD 820	21	128	114	25 30
MD 820	25	152	138	25 30

* Special sprockets and hub size are being manufactured on your request.

MD 880 Sprockets Technical Drawings

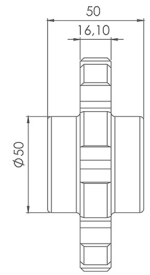
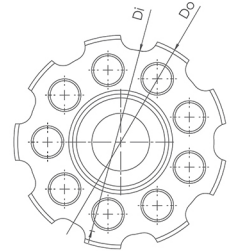

Classic Sprocket Series MD880

Product Code	Number of Teeth	Do (mm)	Di (mm)	Round Bore (Ø)
MD 880	9	111	97	25 30
MD 880	11	135	121	25 30

* Special sprockets and hub size are being manufactured on your request.

MD 1701 R Sprockets Technical Drawings

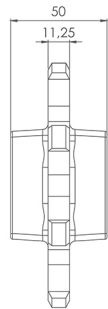
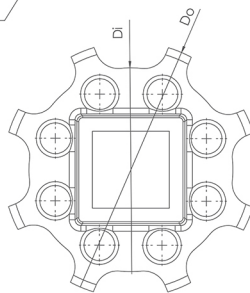

Classic Sprockets Series MD1701

Product Code	Number of Teeth	Do (mm)	Di (mm)	Round Bore (Ø)	Square Bore
MD 1701 R	8	132	107	25 30	40 x 40
MD 1701 R	10	166	107	25 30	40 x 40

* Special sprockets and hub size are being manufactured on your request.

Flexi Chains Sprocket Technical Drawings

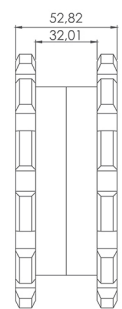
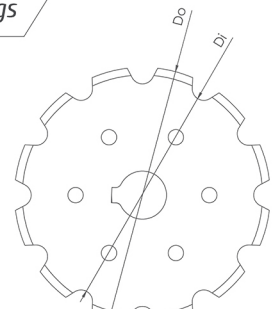
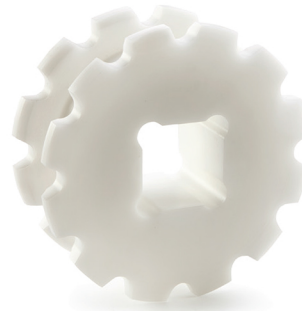

Classic Sprockets Series Flexi Chains

Product Code	Number of Teeth	Do (mm)	Di (mm)	Round Bore (Ø)	Square Bore
FLEXI CHAIN	12	133	115	25 30	40 x 40

* Special sprockets and hub size are being manufactured on your request.

MD 600 S Sprockets Technical Drawings

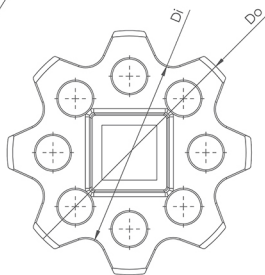
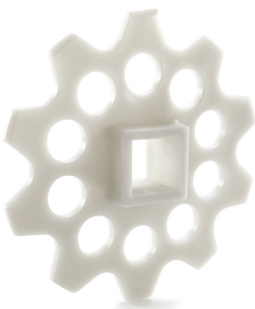

Classic Sprockets Series MD600

Product Code	Number of Teeth	Do (mm)	Di (mm)	Round Bore (Ø)	Square Bore
MD 600	8	177	138	25 30	40 x 40
MD 600	10	221	176	25 30	40 x 40

* Special sprockets and hub size are being manufactured on your request.