

HabaCHAIN® Slat and Conveyor Chains

Product Overview

Habasit—Solutions in motion



Flexible chain solutions tailored to your needs	3
Application table	4
Your benefits at a glance	5
Product overview	
- Slat top chains	6
- Low back pressure chains	6
- Flexi chains	7
- Snap-on chains	7
- Multiflex chains	7
- Case chains	8
The Multi-Hub sprocket design	9
Sprockets, idlers, and inserts	
- Multi-Hub sprockets, idlers, and inserts	10
- Solid sprockets and idlers	11
- Solid sprockets	12
Low friction chains and high friction inserts	13
Material overview	14
The Habasit solution	15
Contacts	16

This **disclaimer** is made by and on behalf of Habasit and its affiliated companies, directors, employees, agents and contractors (hereinafter collectively "HABASIT") with respect to the products referred to herein (the "Products"). SAFETY WARNINGS SHOULD BE READ CAREFULLY AND ANY RECOMMENDED SAFETY PRECAUTIONS BE FOLLOWED STRICTLY! Please refer to the Safety Warnings herein, in the Habasit catalogue as well as installation and operating manuals. All indications / information as to the application, use and performance of the Products are recommendations provided with due diligence and care, but no representations or warranties of any kind are made as to their completeness, accuracy or suitability for a particular purpose. The data provided herein are based on laboratory application with small-scale test equipment, running at standard conditions, and do not necessarily match product performance in industrial use. New knowledge and experience may lead to re-assessments and modifications within a short period of time and without prior notice. EXCEPT AS EXPLICITLY WARRANTED BY HABASIT, WHICH WARRANTIES ARE EXCLUSIVE AND IN LIEU OF ALL OTHER WARRANTIES, EXPRESS OR IMPLIED, THE PRODUCTS ARE PROVIDED "AS IS". HABASIT DISCLAIMS ALL OTHER WARRANTIES, EITHER EXPRESS OR IMPLIED, INCLUDING, BUT NOT LIMITED TO, IMPLIED WARRANTIES OF MERCHANTABILITY, FITNESS FOR A PARTICULAR PURPOSE, NON-INFRINGEMENT, OR ARISING FROM A COURSE OF DEALING, USAGE, OR TRADE PRACTICE, ALL OF WHICH ARE HEREBY EXCLUDED TO THE EXTENT ALLOWED BY APPLICABLE LAW. BECAUSE CONDITIONS OF USE IN INDUSTRIAL APPLICATION ARE OUTSIDE OF HABASIT'S CONTROL, HABASIT DOES NOT ASSUME ANY LIABILITY CONCERNING THE SUITABILITY AND PROCESS ABILITY OF THE PRODUCTS, INCLUDING INDICATIONS ON PROCESS RESULTS AND OUTPUT.



The HabaCHAIN® product line

The HabaCHAIN® product line is designed, produced and serviced by a worldwide leader in conveyor belting – Habasit. HabaCHAIN® products offer world class quality and innovation combined with excellent reliability and cost efficiency.

HabaCHAIN® products are available in straight running and side-flexing versions. HabaCHAIN® is completely compatible with industry standards which allows for easy retrofits without conveyor modifications.

HabaCHAIN® products are available in a wide variety of problem solving materials such as, low friction, enhanced chemical resistance, anti-static, high temperature and magnetic.

Industries served

- Beverage • Canning • Bakery • Snack foods
- Meat - poultry - fish • Packaging • Dairy
- Electronics • Pharmaceuticals • Automotive
- Materials handling • Cardboard • Tissue • Textiles

Your solutions partner

Habasit is committed to understanding your design parameters and application needs. After reviewing your requirements, our engineering staff will suggest the best solution for each application.

Global expertise

With over 60 years of experience, the widest and most innovative product range, and an extensive global network, Habasit is the undisputed No. 1 in belting worldwide. We are dedicated to meeting your needs for innovative, high-quality, and perfectly serviced chain solutions.



Applications	Slat top chains plastic	Slat top chains steel	Low back pressure chains LBP	Snap-on chains	Flexi chains	Case chains	Multiflex chains
Beverage	•	•	•	•		•	•
Canning	•	•	•	•		•	•
Bakery	•	•	•	•		•	
Snack foods	•		•			•	
Meat	•	•				•	
Poultry	•	•				•	
Fish	•	•				•	
Packaging	•	•	•	•	•	•	•
Dairy	•	•	•	•		•	•
Electronics	•				•		
Pharmaceuticals	•		•		•	•	
Automotive	•	•	•	•	•	•	•
Materials handling	•	•	•	•	•	•	•
Cardboard	•		•	•		•	
Tissue	•		•	•		•	•
Textiles	•					•	•

For detailed material and belt selection please contact your local Habasit partner: www.habasit.com

Features and benefits



Key features	Your benefits
<ul style="list-style-type: none"> • High tensile strength 	<ul style="list-style-type: none"> → Less downtime, maximize conveyor line layouts
<ul style="list-style-type: none"> • Low friction materials 	<ul style="list-style-type: none"> → Excellent for high speed applications
<ul style="list-style-type: none"> • Bevel edges 	<ul style="list-style-type: none"> → Product stability over multiple strand conveyance
<ul style="list-style-type: none"> • High friction inserts 	<ul style="list-style-type: none"> → Unique product conveying solutions
<ul style="list-style-type: none"> • Wide range of specialty materials 	<ul style="list-style-type: none"> → Total coverage for all your application needs

Innovative patented products



We offer	You get
<ul style="list-style-type: none"> • Multi-hub sprockets and idler design 	<ul style="list-style-type: none"> → Unique design concept allows for separating the tooth segment from the hub/bore insert → This provides flexibility to optimize inventory while reducing carrying cost
<ul style="list-style-type: none"> • 7100 chain design 	<ul style="list-style-type: none"> → Increased versatility through a two-piece chain
<ul style="list-style-type: none"> • Low-backline pressure (LBP) solution 	<ul style="list-style-type: none"> → Reduced back pressure → Noise reduction → Better load stability → Reduced vibration.
<ul style="list-style-type: none"> • Insert of special sliding block for LBP's in place of the intermediate shaft 	<ul style="list-style-type: none"> → Better stability → Noise reduction → Low product residual push
<ul style="list-style-type: none"> • Unique magnetic solution for improved tracking 	<ul style="list-style-type: none"> → Noise reduction → Better cleanability

Slat top chains – Low back pressure chains

Slat Top chains (plastic)



770T (radius)



820 (straight)



821 (straight)



828 (straight)



831 (straight)



879B (radius)



879T (radius)



880B (radius)



880LJ (radius)



880J (radius)



880T (radius)



880M (radius)



882B (radius)



882T (radius)



882TG (radius)



890T (radius)



1061M (radius)



1061T (radius)



1071B (radius)

Low back pressure chains LBP



LBP 821 (straight)



LBP 821 SB (straight)



LBP 882T (radius)



LBP 882T SB (radius)

Slat Top chains (steel)



800 (straight)



810 (straight)



881B (radius)



881T (radius)

Flexi chains – Snap-on chains – Multiflex chains

Flexi chains



7100HA

Snap-on chains



843 (straight)



843C (straight)



863 (straight)



863T (straight)



963 (straight)



963T (straight)



1843T (radius)



1873T (radius)



1873T+T (straight)



1873+D1 (radius)



1873+L4 (radius)



1874T (radius)



3873T (radius)

Multiflex chains



1700 (radius)



1701T (radius)



1702 (radius)

Case chains



40P (straight)



60P (straight)



600 (radius)



601 (radius)



610T (radius)



611T (radius)



611TE (radius)



1100 (straight)



1110T (radius)



1150 (straight)



1151T (radius)



1200 (straight)



1201AB (straight)



1210T (radius)



1211TB (radius)



1250 (straight)



1251T (radius)



1400 (radius)



1410T (radius)



3200 (straight)



3210T (radius)



NH78 (radius)

Sprockets

The Multi-Hub sprocket design

Multi-Hub

Habasit's Patented Multi-Hub Split Sprocket and Split Idler Wheel design allows customers the flexibility to interchange sprocket tooth and idler rims with a wide variety of hub inserts. They are available with various bore sizes and configurations which provides flexibility to optimize inventory while reducing carrying cost.

1. Complete Multi-Hub split sprocket
2. Interchangeable Multi-Hub split idler wheel rim
3. Interchangeable Multi-Hub split sprocket tooth rim
4. Interchangeable Multi-Hub insert with round bore, keyway and setscrew for drive sprocket applications
5. Interchangeable Multi-Hub insert with plain round bore for idler sprocket applications

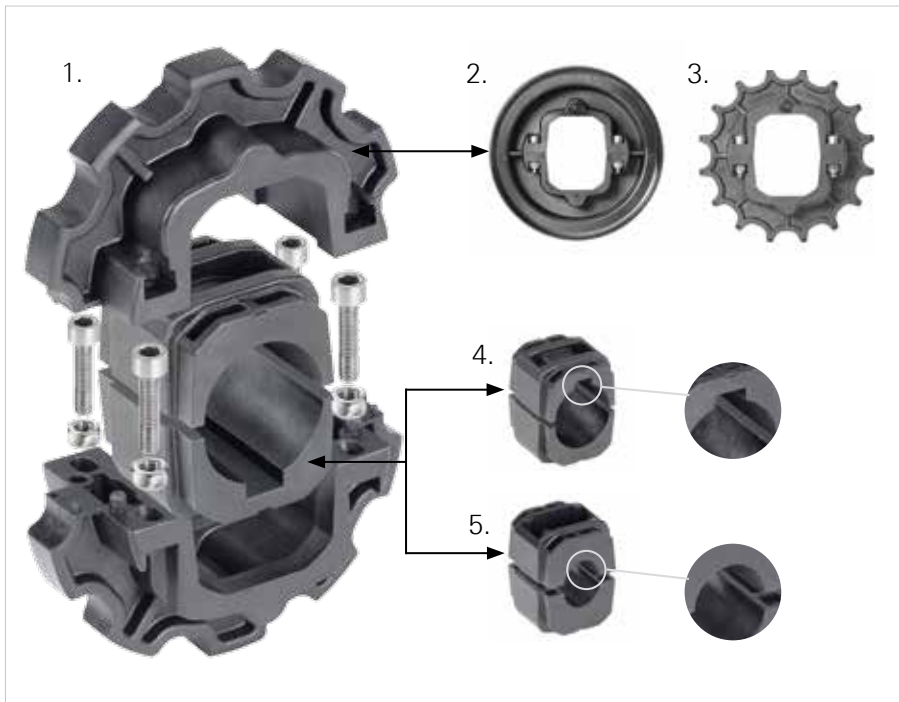

Multi-Hub inserts for idler and drive application







For round shafts Ø		For square shafts (width/height)	
mm	inch	mm	inch
25	1	40	1.5
30	1 3/16		
35	1.25		
40	1 7/16		
	1.5		

Retainer rings



For round shafts Ø		For square shafts (width/height)	
mm	inch	mm	inch
20	1	25	1
25	1 3/16	40	1.5
30			
40			

Multi-Hub sprockets and idlers

	Type	Number of teeth	Suitable for chains
	Multi-Hub 820 idler rims	21 23 25	Slat Top plastic: 820, 828, 831, 879B, 880B, 880J, 880LJ, 880M, 1061M Slat Top steel: 810, 881B
	Multi-Hub 820 sprocket rims	21 23 25	Slat Top plastic: 820, 831 Slat Top steel: 810
	Multi-Hub 821 sprocket rims	25	Slat Top plastic: 821 Slat Top steel: 800 LBP: 821
	Multi-Hub 880 sprocket rims	10 12	Slat Top plastic: 828, 879, 880, 890
	Multi-Hub 882 sprocket rims	12	Slat Top plastic: 882 LBP: 882

Solid sprockets and idlers

	Type	Number of teeth	Suitable for chains
	Solid idler series 810	19, 21, 23, 25, 27	Slat Top plastic: 820, 828, 831, 879B, 880J, 880LJ, 880M, 1061M Slat Top steel: 810, 881B
	Solid idler series 7100	16 21	Flexi chain: 7100
	Solid sprocket series 600	6 8 10 12 14	Case chain: 600
	Solid sprocket series 810	19, 21, 23, 25, 27, 31	Slat Top steel: 810
	Solid sprocket series 820	17, 19, 21, 23, 25, 27, 31	Slat Top plastic: 820, 831 Slat Top steel: 810
	Solid sprocket series 821	19, 21, 23, 25, 27, 29, 31	Slat Top plastic: 821 Slat Top steel: 800 LBP: 821
	Solid sprocket series 880	9, 10, 11, 12, 13, 14, 15	Slat Top plastic: 828, 879, 880, 890
	Solid sprocket series 881	19, 21, 23, 25, 27, 31	Slat Top steel: 881
	Solid sprocket series 882	9, 10, 11, 12, 13, 14, 15	Slat Top plastic: 882 LBP: 882
	Solid sprocket series 1100	7, 9, 10, 11, 12, 14, 15, 16, 17, 19	Case chain: 1100

Solid sprockets

	Type	Number of teeth	Suitable for chains
	Solid sprocket series 1150	7, 9, 10, 12, 14, 15, 16, 17	Case chain: 1150
	Solid sprocket series 1200	8, 12, 15, 17	Case chain: 1200, 3200
	Solid sprocket series 1250	8, 12, 15, 17	Case chain: 1250
	Solid sprocket series 1400	6, 8, 10	Case chain: 1400
	Solid sprocket series 1700	8, 10, 12, 13	Multiflex chain: 1700
	Solid sprocket series 3200	8, 10, 12, 15, 17, 19	Case chain: 3200
	Solid sprocket series 7100	12, 16	Flexi chain: 7100
	Solid sprocket series NH78	6, 8, 10	Case chain: NH78

Snap-on chains

These use:

- Standard ANSI 40-1 roller chain sprockets from any supplier for 0.5" base chains (08A-1), suitable for 843, and 1843 series
- Standard ANSI 60-1 roller chain sprockets from any supplier for 0.75" base chains (12A-1), suitable for 863, 963, 1873, 1874, 2873, and 3873 series

Case chains

These use:

- Standard ANSI 40-1 or ANSI 60-1 roller chain sprockets from any supplier, suitable for 40P or 60P chains

Low friction

Habasit's "low friction" LF chain material delivers friction properties that meet or exceed those offered by other high performance materials at a premium price. This allows customers to optimize performance at a competitive price so the savings go right to your bottom line.

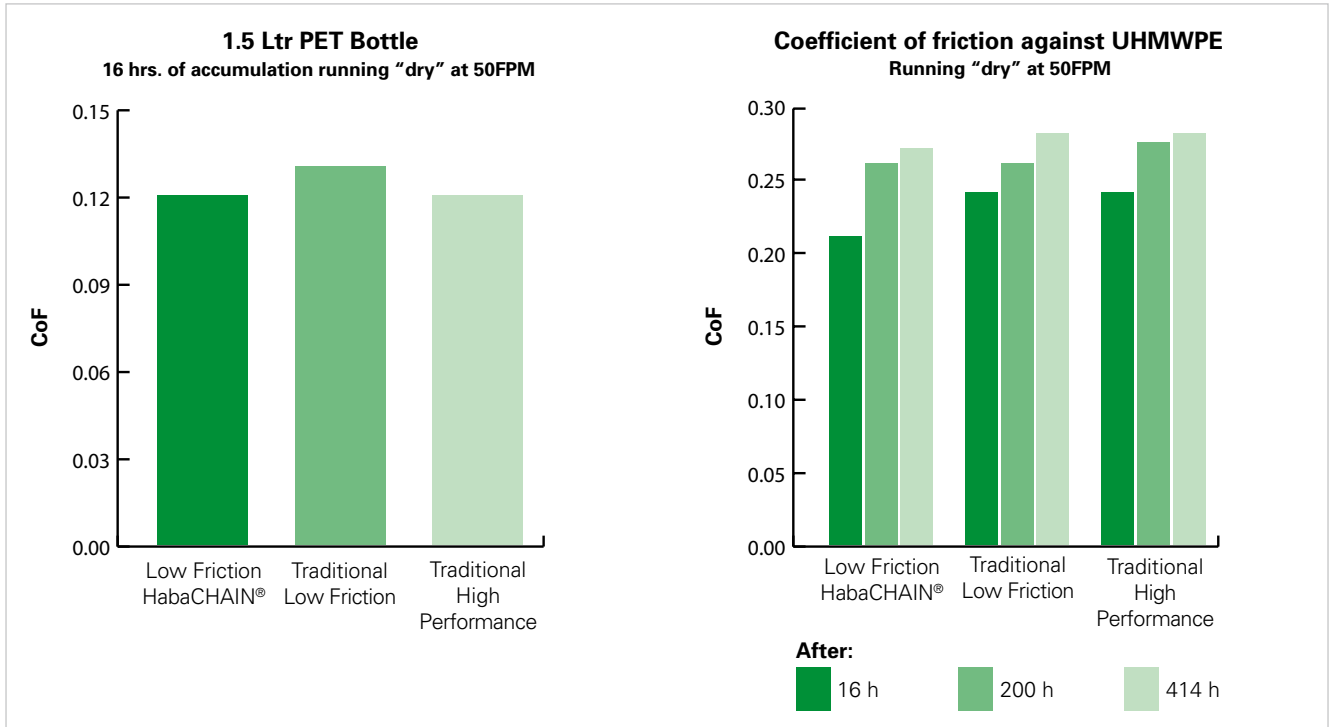

Over molds (high friction inserts)

Habasit's over mold capability allows us to provide high friction inserts in a wide range of profiles to support your conveying application needs.

These high friction inserts are molded directly into the chain for optimum performance and durability.

Habasit's high friction inserts are available in different hardness and can be adapted to almost any HabaCHAIN® style to handle the following applications.

- Inclines
- Declines
- Case/product turning
- Case/product orientation

For further information on availability of standard or custom inserts, please contact Habasit.



Code	Material description	Color
Plastic chains (Standard chain materials)		
DP	Standard POM (Acetal)	Gray
LF	Low-friction POM (Acetal)	Light brown
PT	Extra low-friction POM (Acetal)	Gray brown, Flexi chains: White
TS	Extra low-friction POM (Acetal)	Silver
NG	PBT (Polybutylene Terephthalate) lubricated	Gray
Plastic chains (Special chain materials)		
PK	POM (Acetal) aramidic fiber reinforced	Dark gray
EC	POM (Acetal) electrical conductive	Black
DE	POM (Acetal) metal detectable	Blue
NY	PA (Polyamide) extra wear-resistant	Dark gray
WR	PA (Polyamide) extra wear-resistant	Black
HT	PA (Polyamide) heat resistant	Black
NP	PBT (Polybutylene Terephthalate)	Natural white
PP	PP (Polypropylene) reinforced, chemical resistant	Natural white
CR	PVDF (Polyvinylidene fluoride) extreme chemical resistance	White
Steel chains		
CS	Carbon steel - 43 HRC	Black
SS	Ferritic stainless steel, AISI 430	Gray,
SH	Martensitic stainless steel	Gray
SA	Austenitic stainless steel, AISI 304	Gray
Pins		
SS	Ferritic stainless steel, AISI 430	Gray
SA	Austenitic stainless steel, AISI 304	Gray
IN	Austenitic stainless steel, AISI 316, chemical resistant	Gray
NG	PBT (Polybutylene Terephthalate) lubricated	White
PA	PA (Polyamide) Highly reinforced, wear and fatigue resistant	Gray
Sprockets		
CI	Cast iron	Gray
NY	PA (Polyamide)	Black
PE	PE (Polyethylene)	Natural white
ND	Special noise dampening material	Dark gray
LI	Multi-Hub PA (Polyamide)	Black



Customers first

At Habasit we understand that our success depends on your success. This is why we offer solutions, not just products; partnership, not just sales.

Since our foundation in 1946, Habasit has brought this understanding of customer needs to life every day and for every application. That's why we're the No. 1 in belting today. Worldwide.
Learn more on www.habasit.com

Committed to innovation

Because our customers' belting challenges and needs never cease, we consistently dedicate a substantial percentage of our employees and resources to the research and development of new products and solutions.

Certified for quality

We deliver the highest quality standards not only in our products and solutions, but also in our employees' daily work processes. Habasit AG is certified according to ISO 9001:2008.



Worldwide leading product range

Habasit offers the largest selection of belting, conveying, processing and complementary products in the industry. Our response to any request is nothing less than a specific, tailor-made solution.

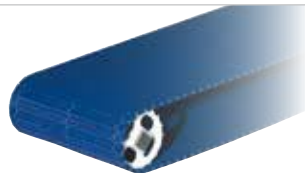

Fabric-based conveyor and processing belts
HabaFLOW®

Plastic modular belts
HabasitLINK®

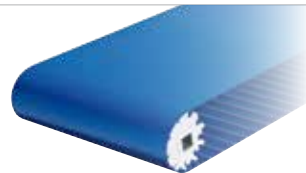

Monolithic reinforced conveyor belts
Habasit Cleandrive™



Power transmission belts
HabaDRIVE®



Timing belts
HabaSYNC®



Chains (slat and conveyor chains)
HabaCHAIN®



Machine tapes

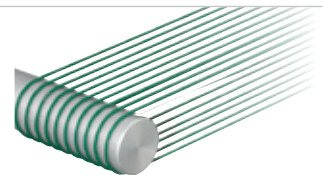

Round belts



Seamless belts



Profiles, guides, wear strips
HabiPLAST®



Fabrication tools (joining tools)



Gearmotors
Electric motors
Motion control

Australia

Habasit Pty Ltd.
Silverwater
Phone: +61 1300 945 455
www.habasit.com.au

Austria

Habasit GmbH
Wien
Phone: +43 1 690 66
www.habasit.at

Belgium

Habasit Belgium N.V.
Zaventem
Phone: +32 27 250 430
www.habasit.be
www.habasit.lu

Canada

Habasit Canada Ltd.
Oakville
Phone: +1 905 827 41 31
www.habasit.ca

China

Habasit East Asia Ltd.
Hong Kong
Phone: +85 221 450 150
www.habasit.com.hk

Habasit (Shanghai) Co. Ltd.
Shanghai
Phone: +8621 5488 1228
Phone: +8621 5488 1218
www.habasit.com.hk

France

Habasit France S.A.S.
Mulhouse
Phone: +33 389 338 903
www.habasit.fr

Germany

Habasit GmbH
Eppertshausen
Phone: +49 6071 969 0
www.habasit.de

India

Habasit India
Coimbatore
Phone: +91 422 262 78 79
www.habasit.in

Italy

Habasit Italiana SpA
Customer Care:
Phone: 199 199 333
For int. calls: +39 0438 911 444
www.habasit.it

Japan

Habasit Nippon Co. Ltd.
Yokohama
Phone: +81 45 476 0371
www.habasit.co.jp

Netherlands

Habasit Netherlands BV
Nijkerk
Phone: +31 332 472 030
www.habasit.nl

New Zealand

Habasit Ltd.
Auckland
Phone: 0800 000 070
www.habasit.co.nz

Poland

Habasit Polska Sp. z o.o.
Dąbrowa Górnicza
Phone: +48 32 639 02 40
www.habasit.pl

Russia

OOO Habasit Ltd.
St. Petersburg
Phone: +7 812 600 40 80
www.habasit.ru

Singapore

Habasit Far East Pte. Ltd.
Singapore
Phone: +65 686 255 66
www.habasit.com.sg

South Africa

Habasit South Africa (Pty) Ltd.
Gauteng
Phone: +27 10 001 6770
www.habasit.co.za

Spain

Habasit Hispanica S.A.
Barberà del Vallès
Phone: +34 937 191 912
www.habasit.es

Sweden

Habasit AB
Hindas
Phone: +46 30 122 600
www.habasit.se

Switzerland

Habasit GmbH
Reinach
Phone: +41 61 577 51 00
www.habasit.ch

Taiwan

Habasit (Taiwan) Ltd.
Taipei Hsien
Phone: +886 2 2267 0538
www.habasit.com.tw

Turkey

Habasit Kayis San. Ve Tic. Ltd. Sti.
Istanbul
Phone: +90 444 70 43
www.habasit.com.tr

Ukraine

Habasit Ukraine LLC.
Vinnitsa
Phone: +38 0432 58 47 35
www.habasit.ua

United Kingdom and Ireland

Habasit (UK) Ltd.
Silsden
Phone: +44 844 835 9555
www.habasit.co.uk

USA

Habasit America
Suwanee, Georgia
Phone: +1 800 458 6431
www.habasitamerica.com

Headquarters

Habasit AG
Römerstrasse 1
CH-4153 Reinach, Switzerland
Phone +41 61 715 15 15
Fax +41 61 715 15 55
E-mail info@habasit.com
www.habasit.com



Registered trademarks
Copyright Habasit AG
Subject to alterations
Printed in Switzerland
Publication data:
4122BRO.CHA-en0416HQ